

Virtual Physics

Equation-Based Modeling

TUM, January 17, 2023

Modeling and Simulation of Discontinuous Systems

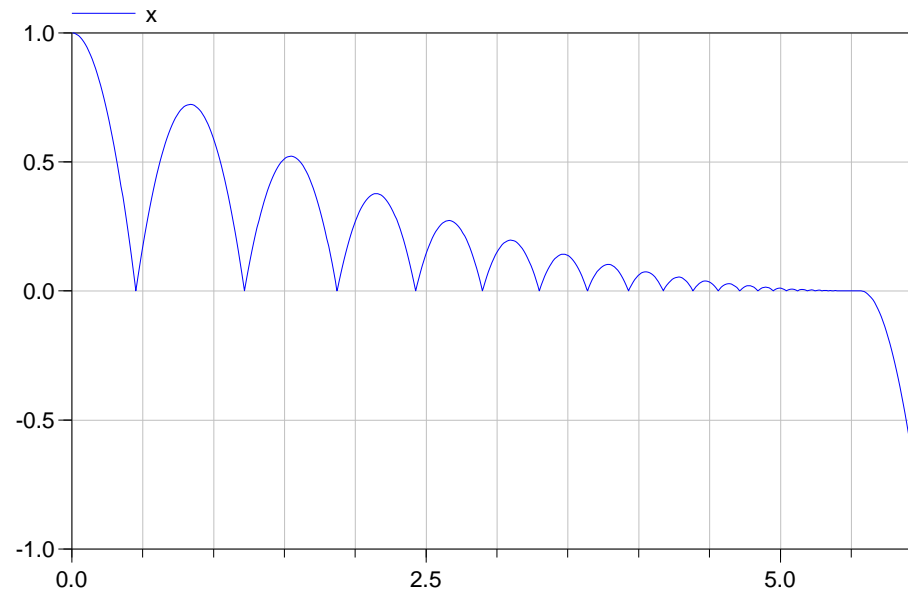

Dr. Dirk Zimmer

German Aerospace Center (DLR), Robotics and Mechatronics Centre

Today, we shall look at the problem of dealing with discontinuities in modeling and simulation.

- Models from engineering often exhibit discontinuities that describe situations such as switching, limiters, dry friction, impulses, or similar phenomena.
- The modeling environment must deal with these problems in special ways, since they influence strongly the numerical behavior of the underlying differential equation solver.

What happens if we simply apply one of our ODE-solvers on a system with discontinuity?

- The discontinuity occurs in $f(\mathbf{x}(t), t)$.
- All ODE-solvers (and their error-estimations) are based on a polynomial approximation of $f(\mathbf{x}(t), t)$.
- Higher-Order methods (order > 1) even suppose that $f(\mathbf{x}, t)$ is differentiable multiple times.

What happens if we simply apply one of our ODE-solvers on a system with discontinuity?

- Polynomials are always continuous and continuously differentiable functions.
- Therefore, when the state equations of the system:

$$dx/dt = f(x(t), t)$$

exhibit a discontinuity, the polynomial extrapolation is a very poor approximation of reality.

- Consequently, integration algorithms with a fixed step size exhibit a large integration error, whereas integration algorithms with a variable step size must reduce the step size dramatically in the vicinity of the discontinuity.

- An integration algorithm of variable step size reduces the step size at every discontinuity.
- After passing the discontinuity, the step size is only slowly enlarged again, as the integration algorithm cannot distinguish between a discontinuity and a point of large local stiffness (with a large absolute value of the derivative).
- The step-size is constantly too small. The integration is inefficient at best if not even totally inaccurate.

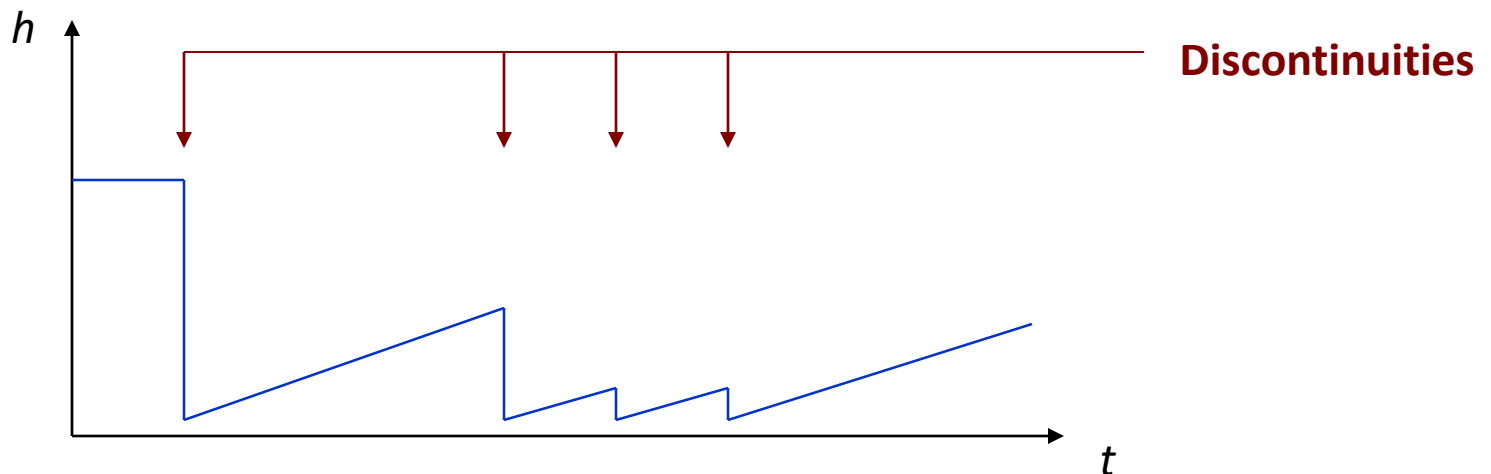

- Trying to handle discontinuities implicitly by standard ODE solvers is evidently not a good solution.
- We can avoid the occurring problems if we model the discontinuities explicitly.
- The expression is one way to do this in Modelica:

```
f = if x < -w then -a else if x < w then a*x/w else a
```

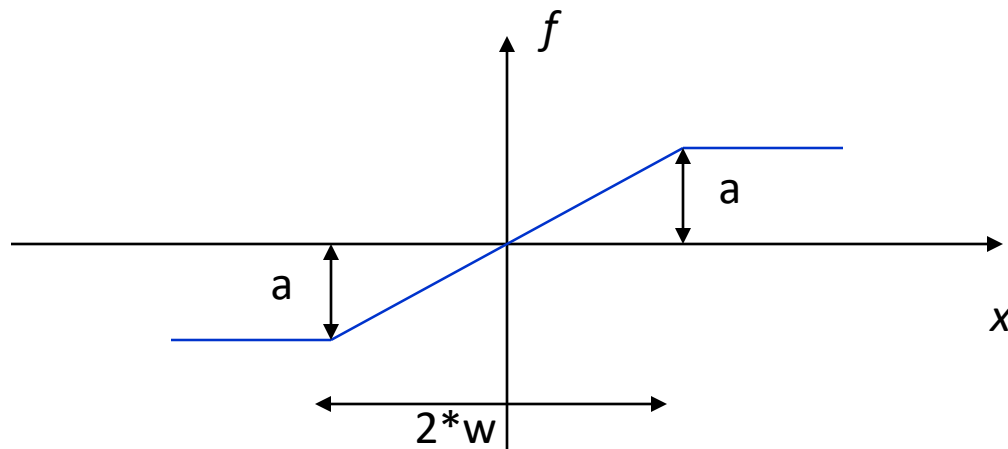

- This if-statement models a state-event since the occurrence of the discontinuity is dependent on the state x .
- An integration algorithm may now precisely locate the event by iterating for the event.
- For instance, by using the bi-section algorithm:

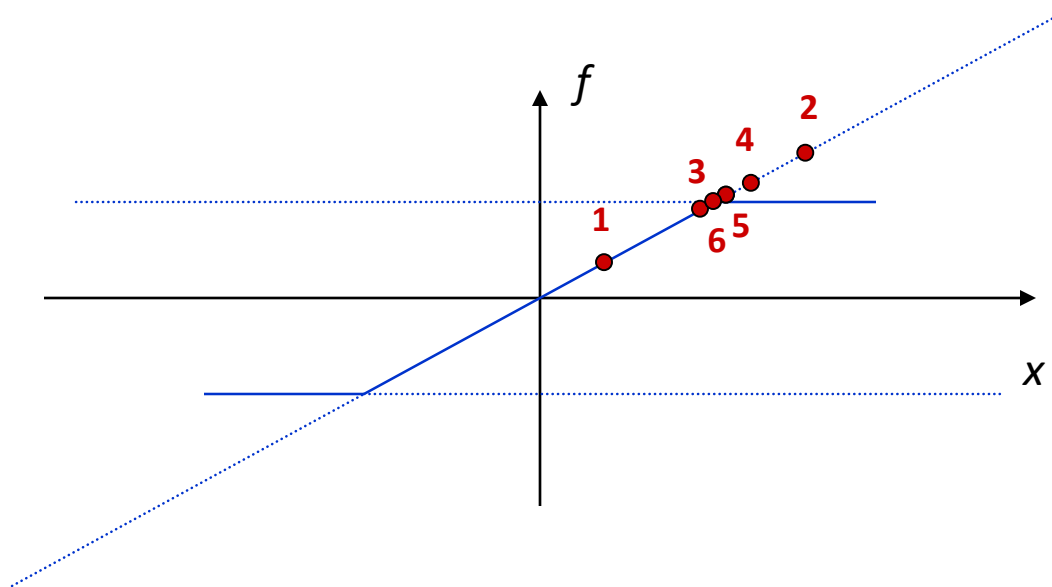

- Bi-section converges slowly. Hence one may prefer the secant method or its “safer”-twin: regula-falsi.
- It is possible to combine the secant method and bi-section
→ Dekker’s methods, Brent’s method.

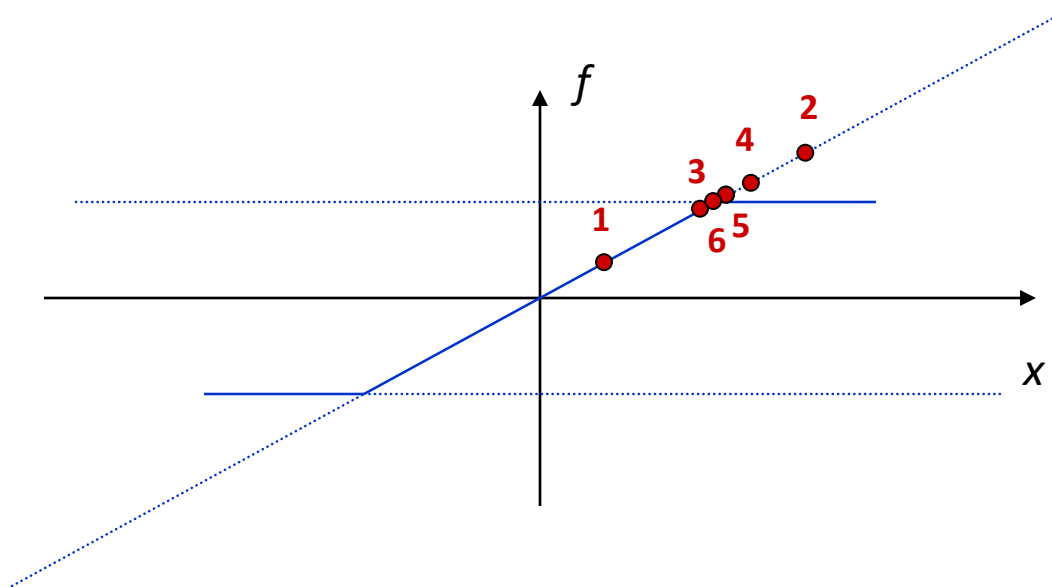

- The iteration for the event-location is thereby performed on the current model equation (here $f = a \cdot x / w$).
- The event itself changes then the model equation (here to $f = a$)

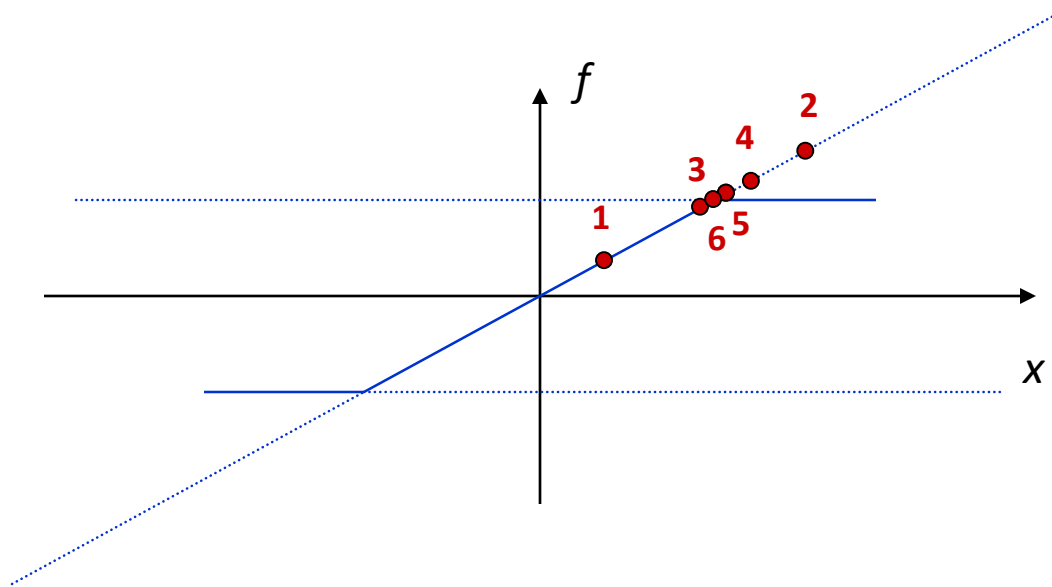

- Sometimes, the event iterations can cause errors in the evaluation (division by zero, negative roots)
- Sometimes, the if-statement is used to model continuous functions.
- Hence the noEvent() clause exists: Example:
`f = noEvent(if x > 0 then sqrt(x) else -sqrt(-x));`
- Here, an event iteration would be both, unnecessary and dangerous. Handling this function is now left to step-size control.

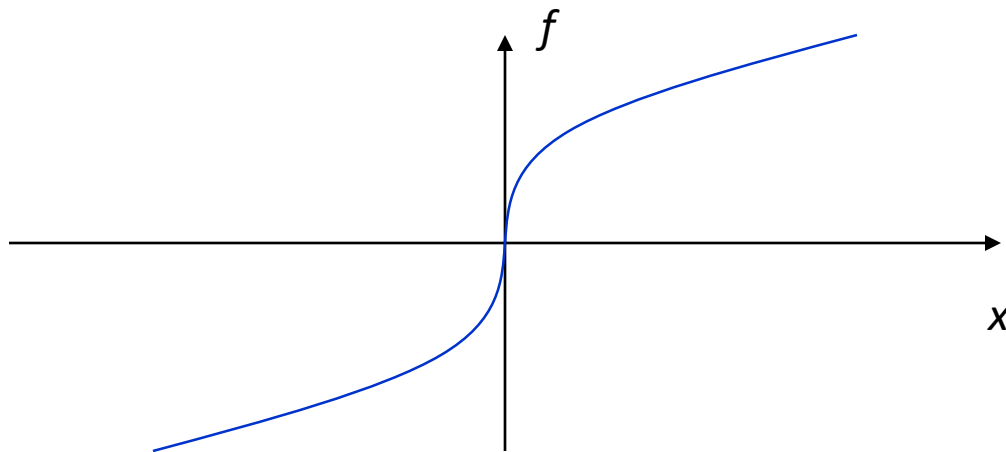

- If we know the precise location of the event, it is sufficient to reduce the size of one single step.
- After passing the discontinuity we switch the model equation and continue with the former step-size.

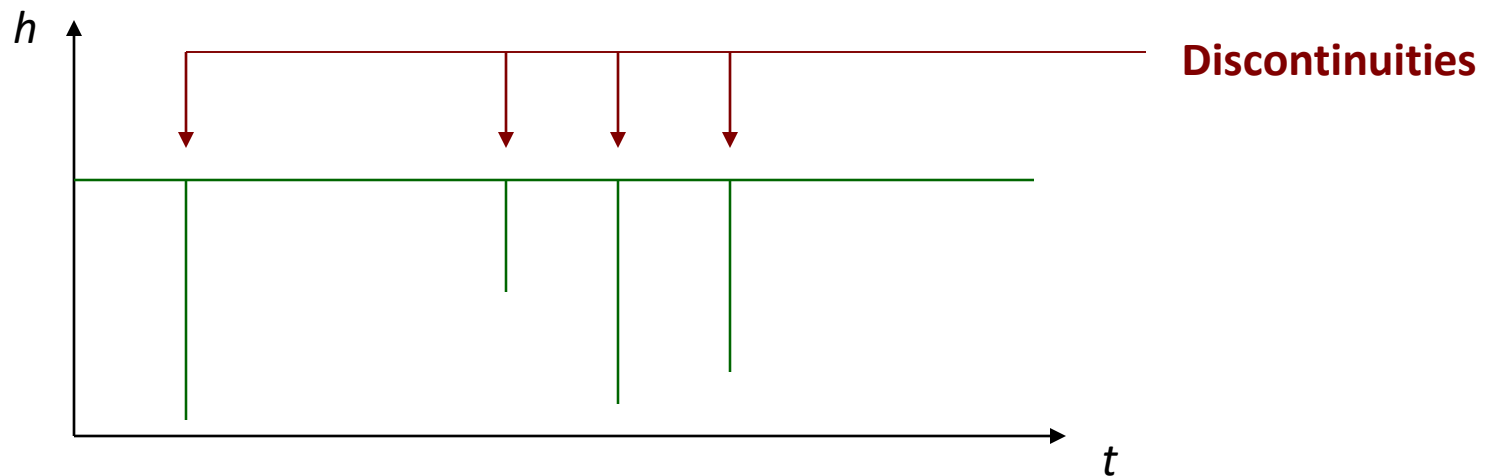

- Evidently, this is much better than abusing step-size control for the treatment of discontinuities.
- We can take much larger step-sizes.

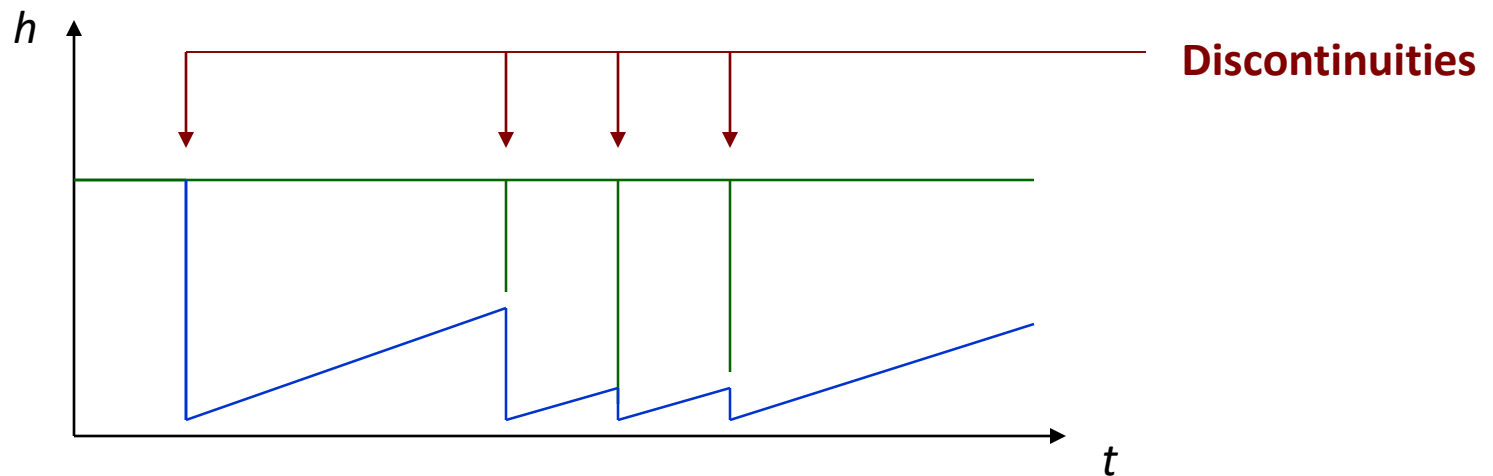

Let us see what we can model with the if-statement.

- For instance, the model of an electrical diode with the following curve.
- Here is one way to model it:

$$u = R \cdot i$$

$$R = \text{if } u > 0 \text{ then } R_{\text{on}} \text{ else } 1/G_{\text{off}};$$

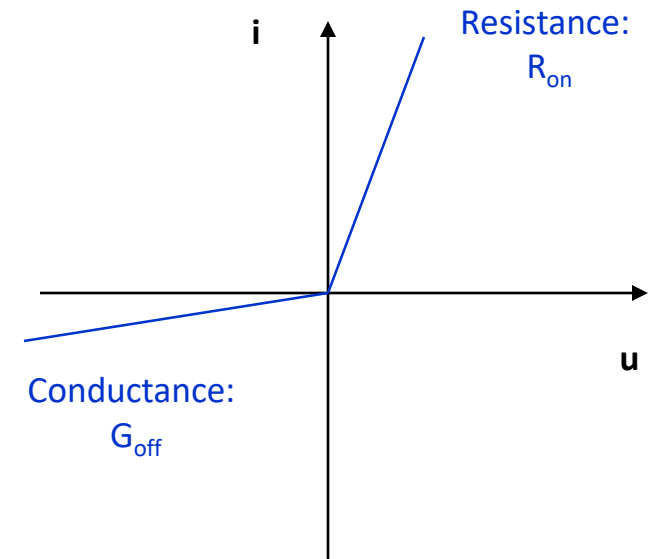
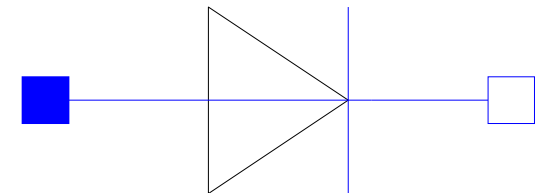

A more compact form is also possible:

```
u = if u>0 then R_on*i else i/G_off;
```

- This is possible because if-expressions are non-causal in Dymola.
- Internally, the if-expressions may be translated into:

```
u = s*R_on*i + (1-s)*i/G_off;
```

with

```
s = 1 if u>0
```

```
s = 0 if u<0
```

- The equation can be solved for u or i.

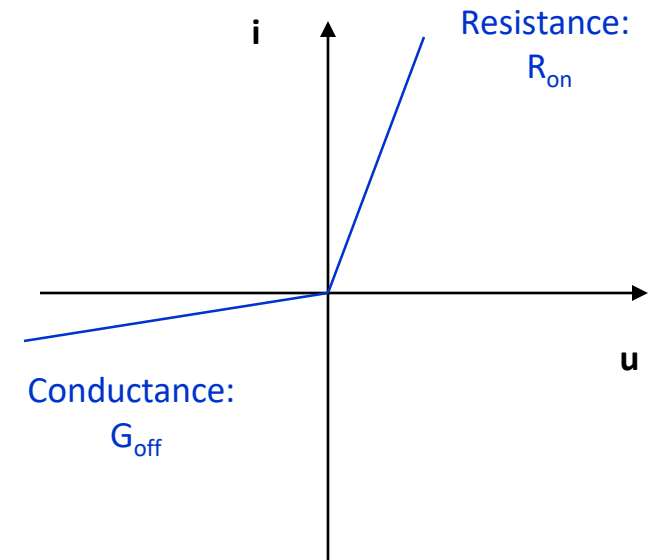
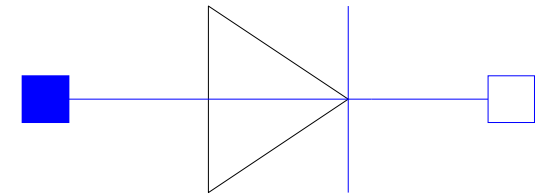

Unfortunately, a truly ideal diode cannot be modeled in this way.

- R_{on} and G_{off} are 0 for an ideal diode.
- The model would be singular in either case.
- We need a different approach. Let us model the diode by a parameterized curve with the curve parameter s .

Blocking diode $u=s$ with $s < 0$

Open diode $i=s$ with $s > 0$

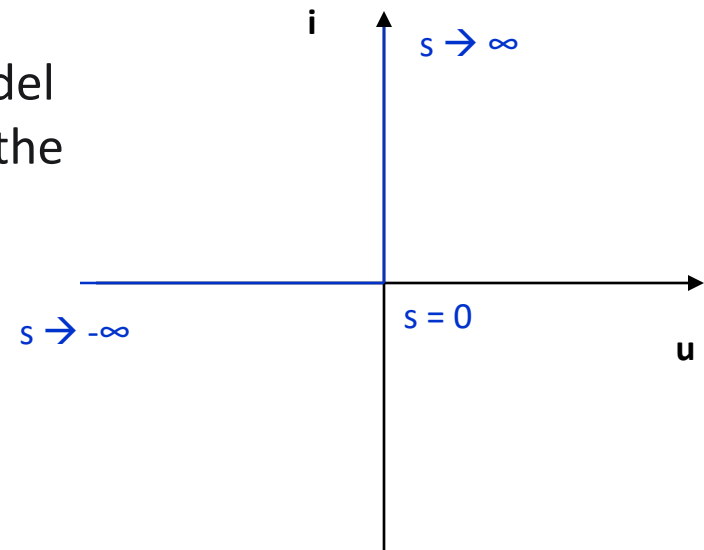
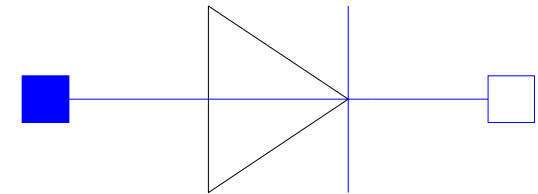

Here are model equations for an ideal diode

```
u = if s>0 then 0 else s;  
i = if s>0 then s else 0;
```

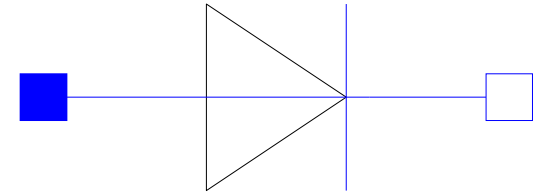

- These are 2 equations over 3 variables. Which are the 2 unknowns?
If u is known the model is singular for $u=0$.
If i is known the model is singular for $i=0$.
Only if s is known the model will be regular.
- But s depends itself on u and i . Hence the model needs to be placed in an algebraic loop and s must be chosen as tearing variable of this loop. (Fortunately, Dymola has an in-built heuristics for this...)

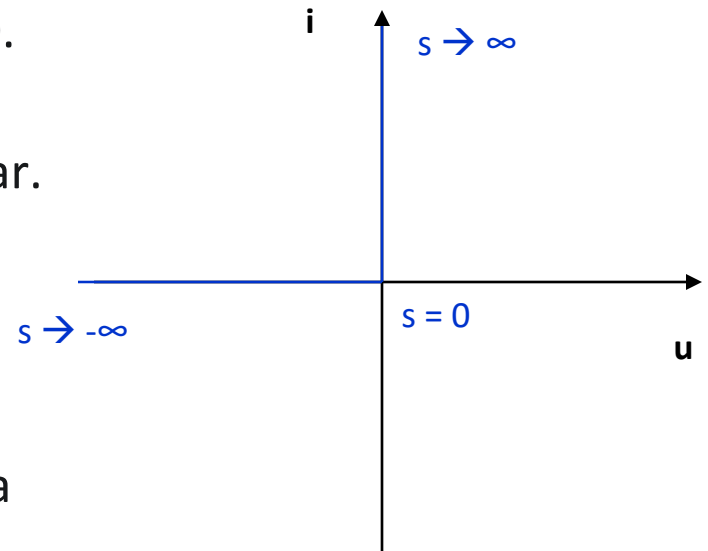

Here is an appropriate example: the halfway-rectifier.

- The ideal diode D and the resistor $R1$ form an algebraic loop that determines the voltage drop between source and capacitance.
- The tearing-variable is the curve-parameter s .

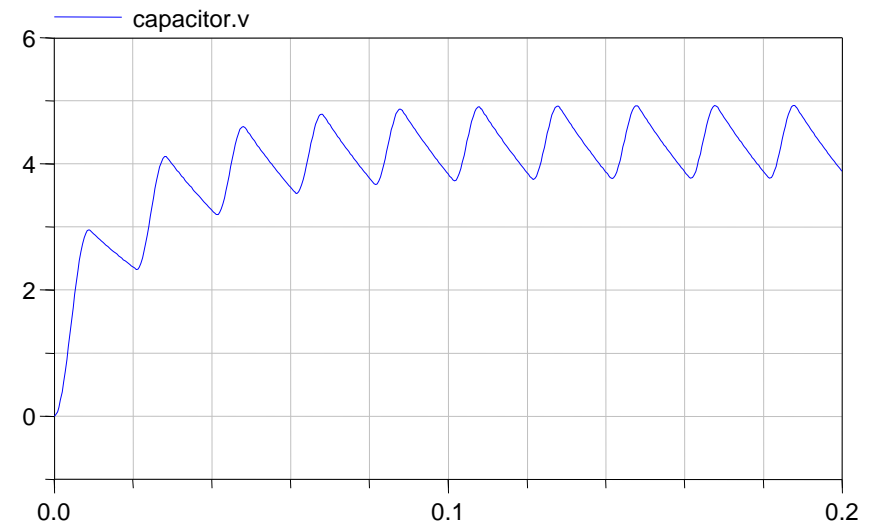
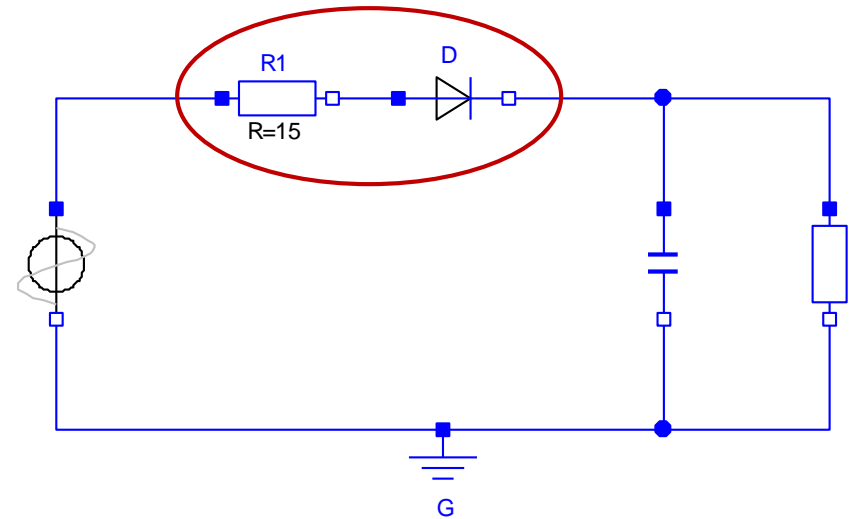

But if we modify this circuit slightly we run into a serious problem.

- We add an inductance in front of the diode.
- Since the natural state-variable of the inductance is the current, the causality of the resistor is fixed and the diode is not part of algebraic loop anymore.
- The simulation fails.
- Let us look closer at this problem.

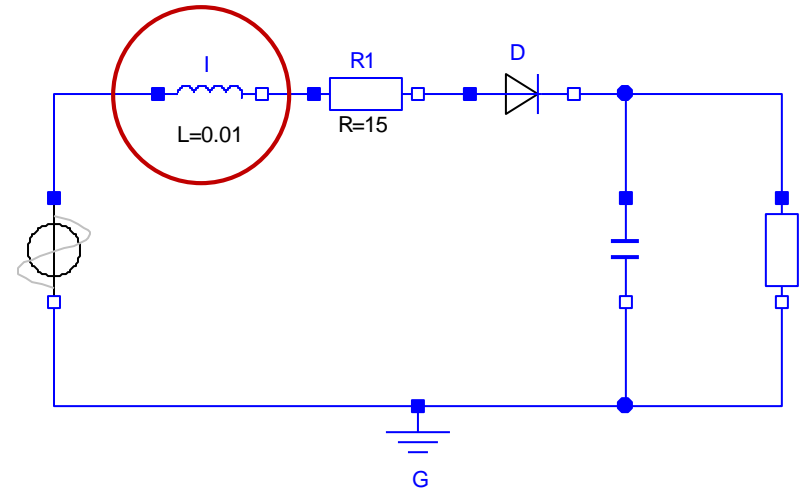

The inductance L contains the differential equation:

$$di/dt * L = u$$

Hence, i is supposed to be known and the causality of the diode is fixed.

The two circuits below represent the two different states of the diode. (either fully open or fully blocking)

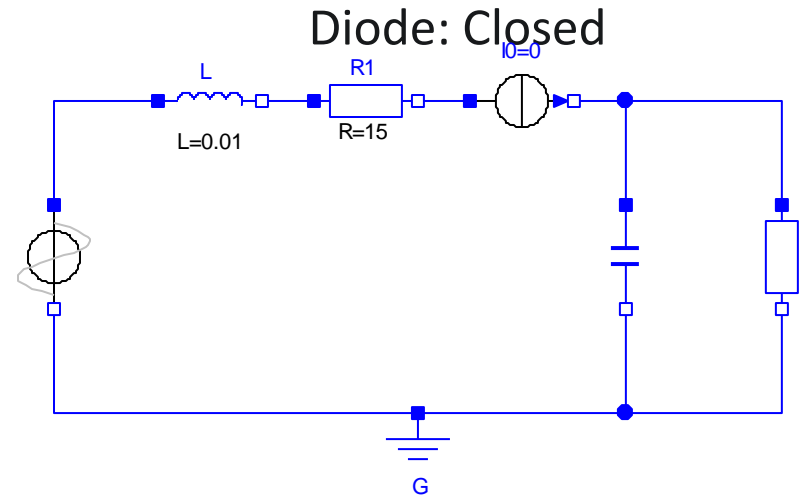
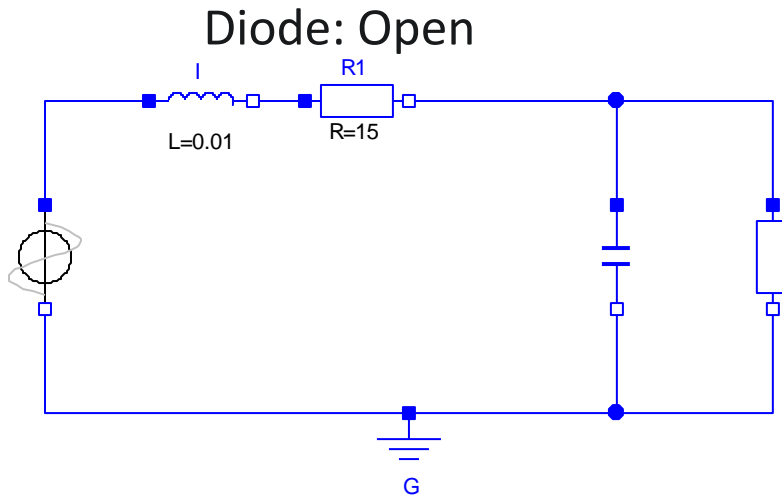

- The two different states of the diode lead to two different systems with different state variables and different perturbation index.
- A severe structural change has been caused by a seemingly harmless equation.
- Dymola is currently unable to handle such variable-structure systems.

So what can we do?

- One solution is to use a non-ideal diode and to avoid the structural change at all. However this implements an artificial stiffness into the system that may be unwanted.
- Fortunately, there is another trick: Inline Integration.
- Inline integration means that we inline the time-discrete equation of the integration algorithm into the model equations.
- To this end, we need to replace the corresponding differential equations.

Let us use inline integration for the halfwave rectifier with line inductance.

- We want to inline Backward Euler (BE or BDF1) into the model of the inductance.
- Hence the differential equation of the inductance:

$$di/dt * L = u$$

- gets replaced by:

$$(i_t - i_{t-h})/h * L = u_t$$

or

$$i_t = i_{t-h} + u_t/L * h$$

with i_t or u_t as potential unknowns

What is the advantage of inline-integration?

- By using inline-integration with BE, we have transformed the equation of the inductance into:

$$i_t = i_{t-h} + u_t/L * h$$

- This equation is structurally equivalent to a resistor equation. It can be solved for i_t as well as for u_t . Hence it can be also part of an algebraic loop.
- For the halfwave-rectifier with line-inductance this means that the equations of the inductance L, the resistor R1, and the Diode D form one algebraic loop using the curve parameter s as tearing variable.
- This kind of inline-integration is also not supported by Dymola. Dymola may perform inline-integration but after the differential index-reduction has taken place. Hence this trick does currently not work in Dymola.

So far, we have only looked at events that could be modeled by if-expressions.
However, also multi-valued functions do frequently occur in engineering systems.

- One example is a function for a hysteretic controller (As used, for instance, in a refrigerator or many other devices that require a binary control).

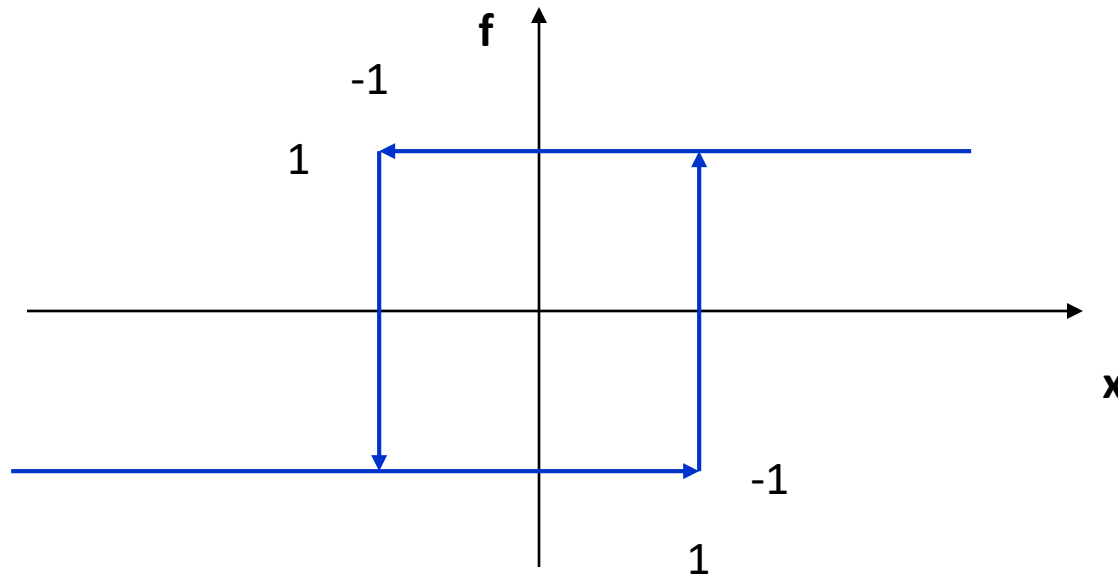

To model such functions, the when-statement has been introduced in Modelica.

```
when  $x > 10$  then  
     $y = -10$   
end when;
```

- The when statement becomes active exactly when its condition becomes true.
- The equation is rather an assignment: The unknown must be placed on the left.
- The equation is only active for this particular time-instance. Right after, it is deactivated again.
- The value of the unknown is held constant until the next activation of the same when-statement.

Hence, the following code seems appropriate to model the hysteresis.

```
when  $x > 1$  then  
     $y = 1$ ;  
end when;  
  
when  $x < -1$  then  
     $y = -1$ ;  
end when;
```

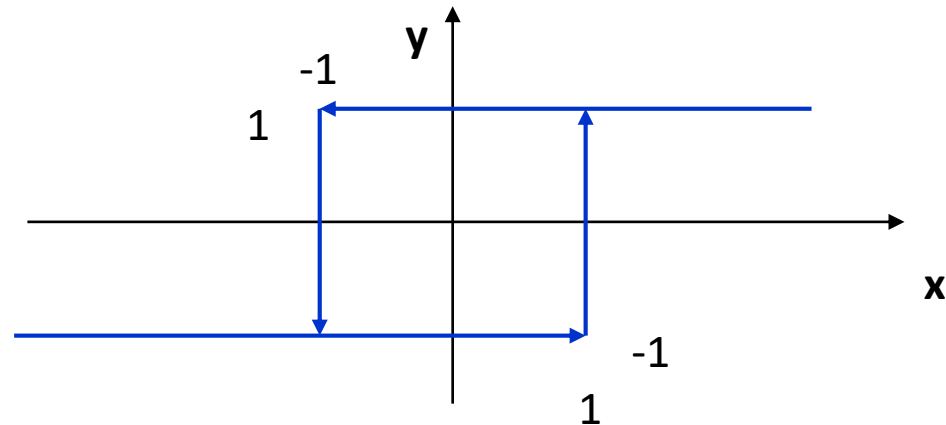

Hence, the following code seems appropriate to model the hysteresis.

```
when x>1 then  
  y = 1;  
end when,  
when x<-1 then  
  y = -1;  
end when;
```

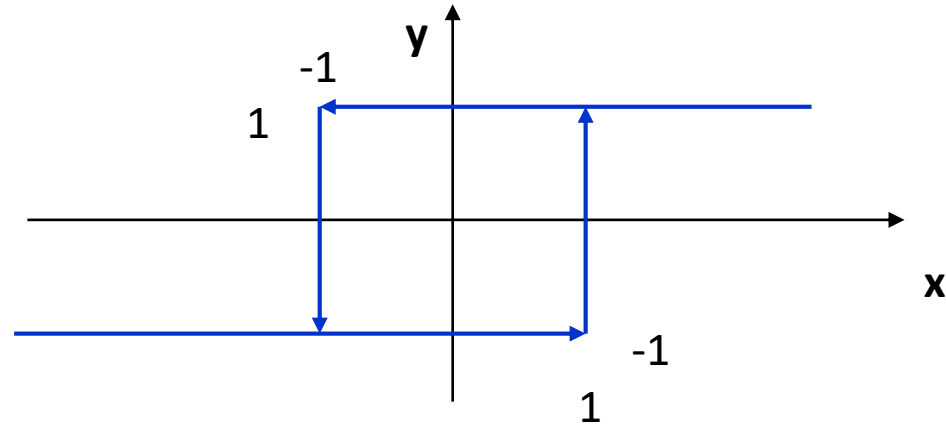

- However, this is illegal in Modelica since the variable y is determined in two distinct when-statements. In order to avoid problems with simultaneous events, this is not allowed.
- Of course, these two events are mutually exclusive, but Dymola does not know this and it is impossible in general to derive this automatically.

Here is an alternative formulation:

```
when  $x > 1$  or  $x < -1$  then  
   $y =$  if  $x > 0$  then 1 else -1;  
end when;
```

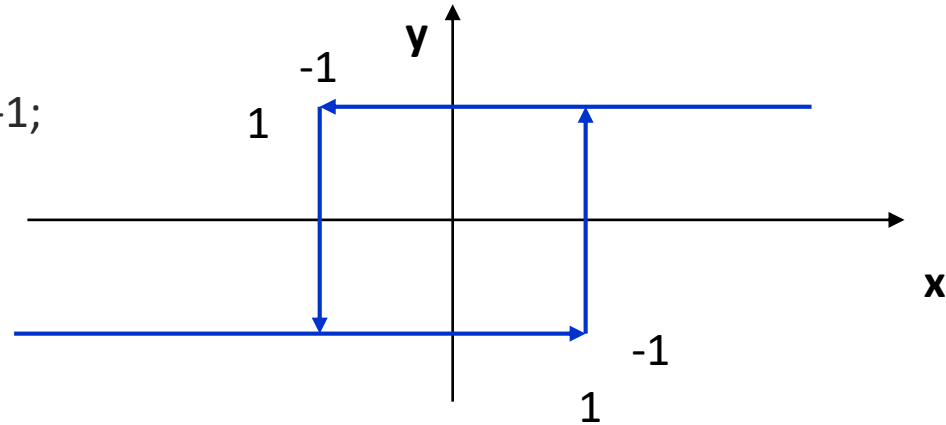

- This is perfectly legal. We have simply merged the two events into a single when-statement.
- By doing so, we have created another problem. Given a large step-size we might jump directly from $x = -1$ to $x = 1$. In this case, no event is triggered at all.

Here is an alternative formulation:

```
when {x>1, x<-1} then  
  y = if x>0 then 1 else -1;  
end when;
```

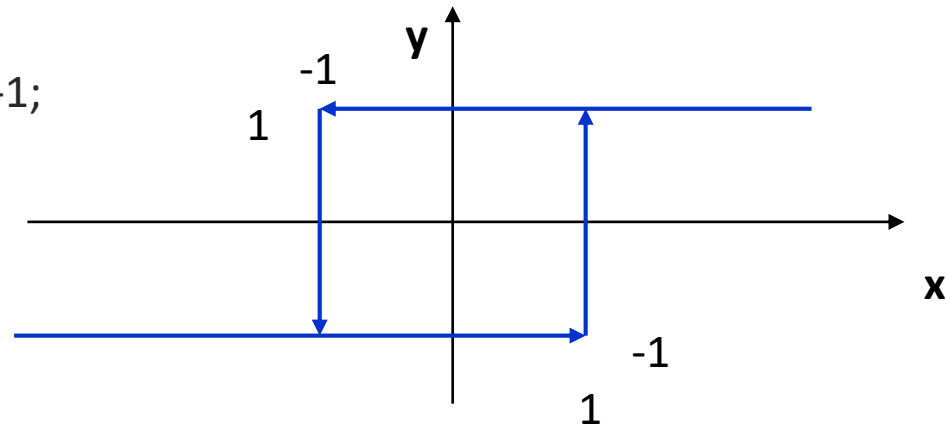

- This is perfectly legal. We have simply merged the two events into a single when-statement.
- By doing so, we have created another problem. Given a large step-size we might jump directly from $x=-1$ to $x=1$. In this case, no event is triggered at all.
- To cope with this problem, Modelica enables to state a condition-vector. Now, we are fine.

In the Modelica Standard Library, the hysteresis is modeled even differently:

```
y = if x > 1 or ((pre(y)>0) and (x>=-1)) then 1 else -1;
```

- The operator `pre(...)` can be used in order to access the value of a variable just right before the event.
- Using this operator, we can formulate multi-valued functions without the use of when-statements.
- As analogy, the statement:

```
when g(...) then  
  y = f(...);  
end when;
```

is internally transformed to....

```
if g(...) and not pre(g(...)) then  
  y = f(...);  
else  
  y = pre(y);  
end if;
```

So far, we have only looked at discrete changes in the function $f(\mathbf{x}(t), t)$

$$d\mathbf{x}/dt = f(\mathbf{x}(t), \mathbf{u}, t)$$

- But there are also cases where the actual state is changing discretely (e.g. mechanical collisions/impulses) . Here dx/dt becomes of infinite value. What shall we do?
- This problem corresponds to the re-initialization of the system.
- In current Modelica, this is only weakly supported by the function `reinit(state, newValue)`.
- Let us look at an example: The bouncing ball.

Bouncing Ball

Let us model a bouncing ball that is being dropped from an initial height and is bouncing on a table.

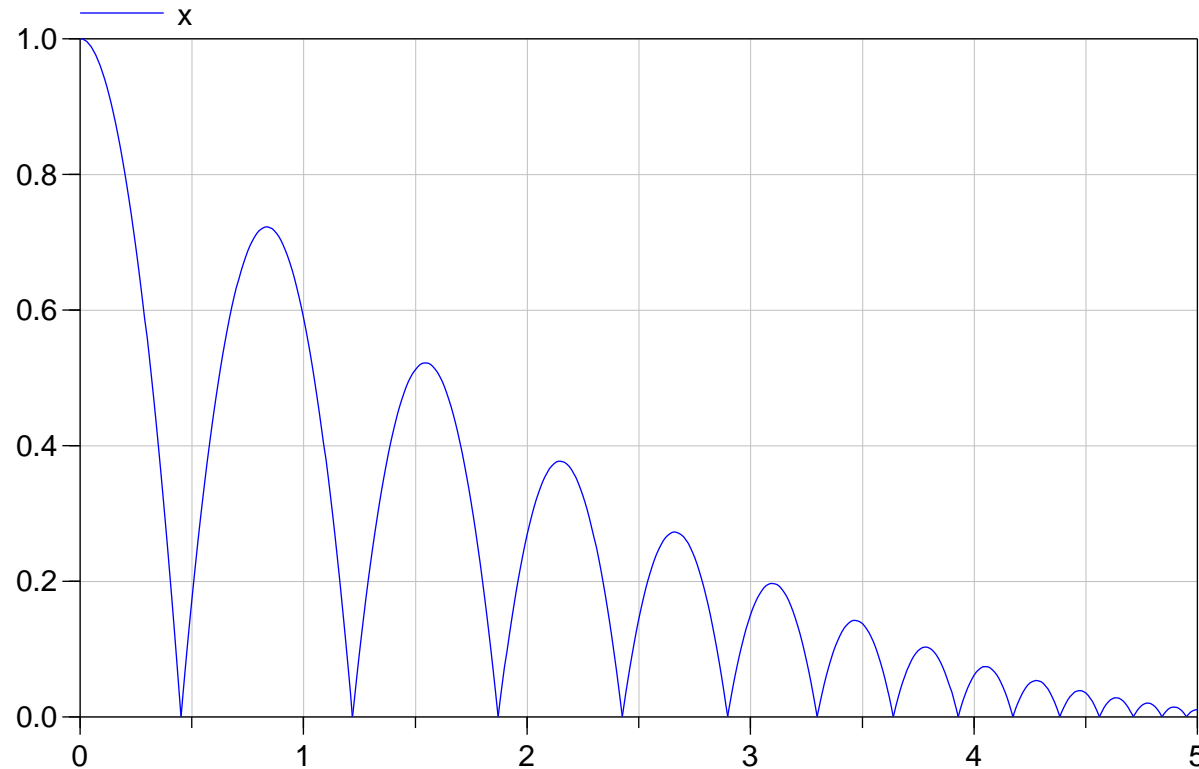

Let us model a bouncing ball that is being dropped from an initial height and is bouncing on a table.

- The motion is described by the variables x , v , and a .
- The elasticity of the impulse is determined by the coefficient μ .
- The `reinit` command is used in a `when`-clause.
- The `pre(...)` operator is used to access the prior value of v in order to compute the new velocity.

```
model BouncingBall

  Real x;
  Real v;
  Real a;

  parameter Real mu = 0.85;

  initial equation
    v = 0;
    x = 1;

  equation
    v = der(x);
    a = der(v);
    a = -9.81;

    when x<0 then
      reinit(v, -mu*pre(v));
    end when;

end BouncingBall;
```

This looks fine. But what happens if we simulate for longer time periods?

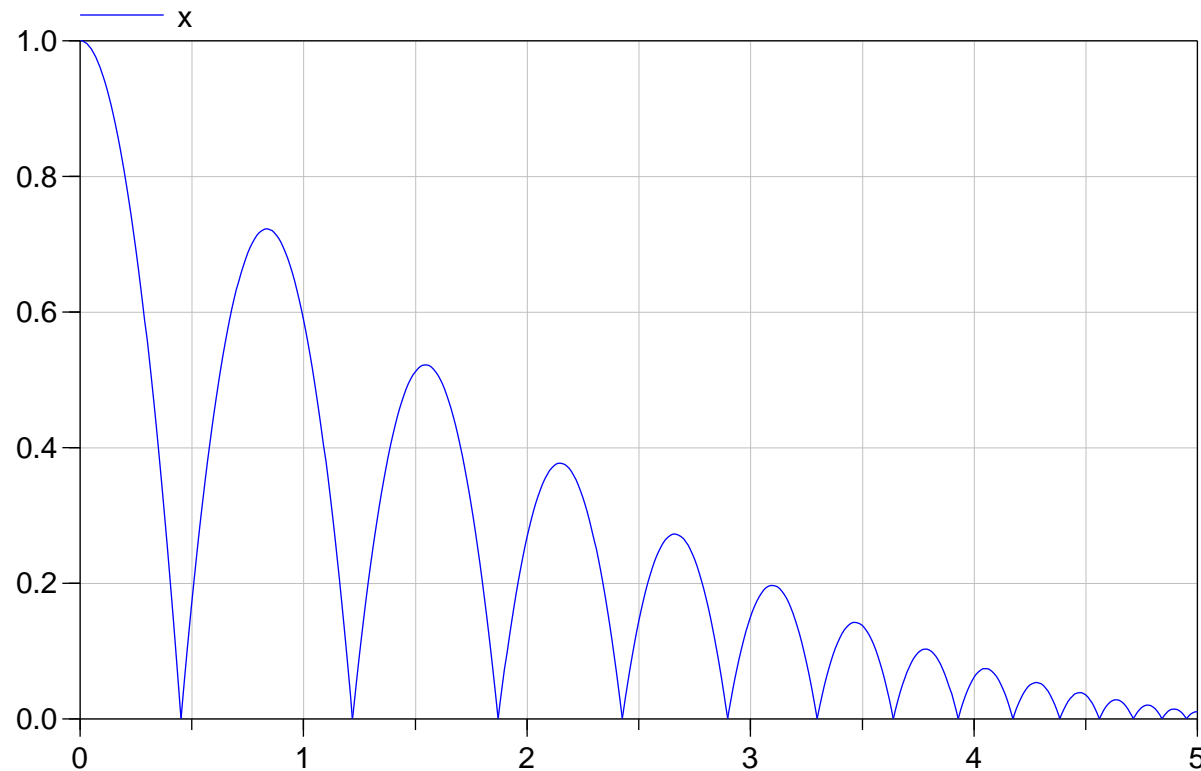

OOOPS!?! This is a common problem among many simulators. The increasingly smaller bounces lead to a failure in the event detection. Modeling a resting state by events is evidently not a good idea.

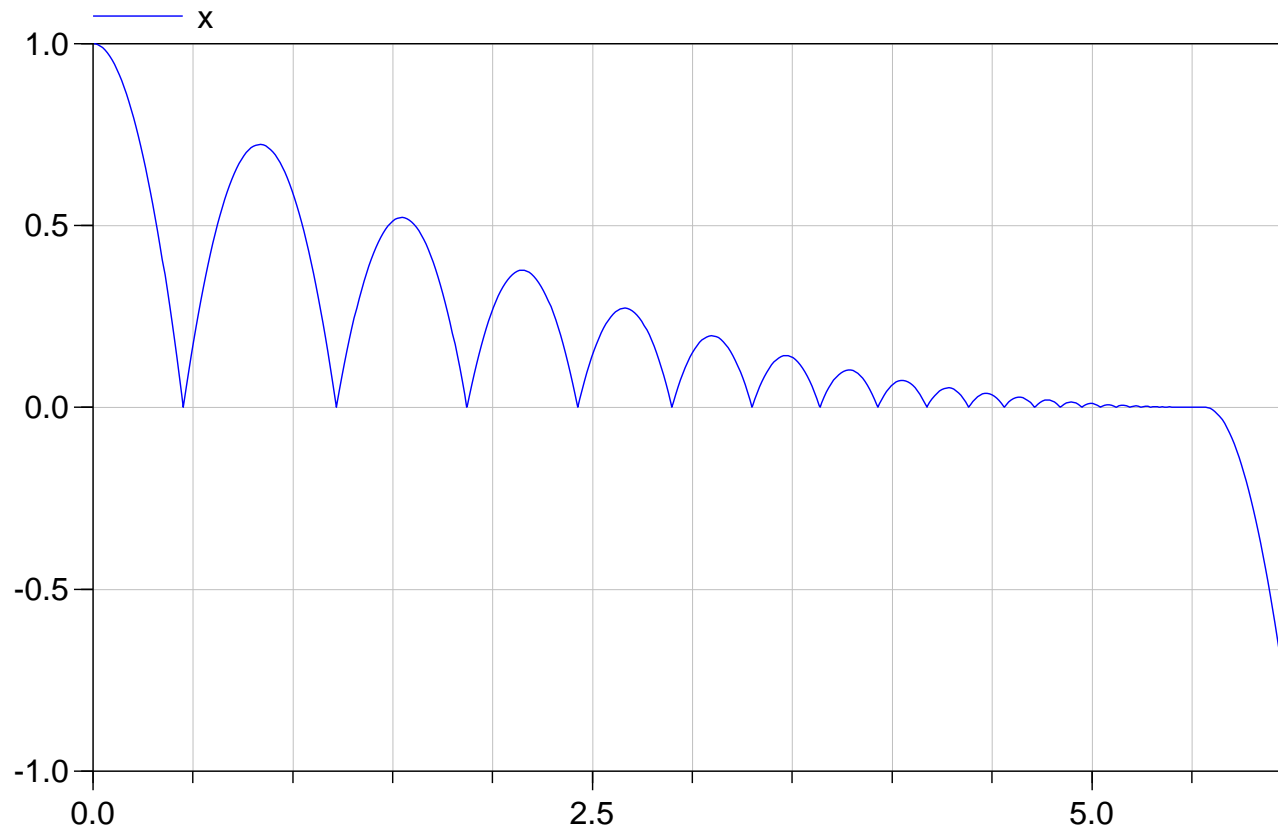

Let us combine what we have learned today by modeling an ideal model for dry-friction.

- For the characteristic curve, we have used so far a regularization. Here is a piecewise linear regularization:

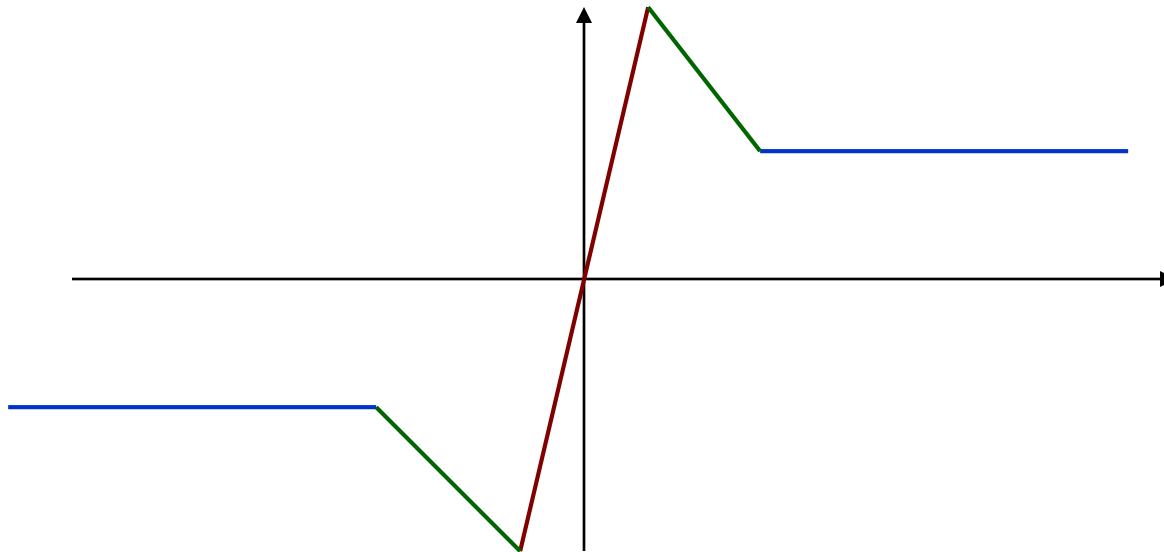

Let us combine what we have learned today by modeling an ideal model for dry-friction.

- In the ideal model, this is a multi-valued function.

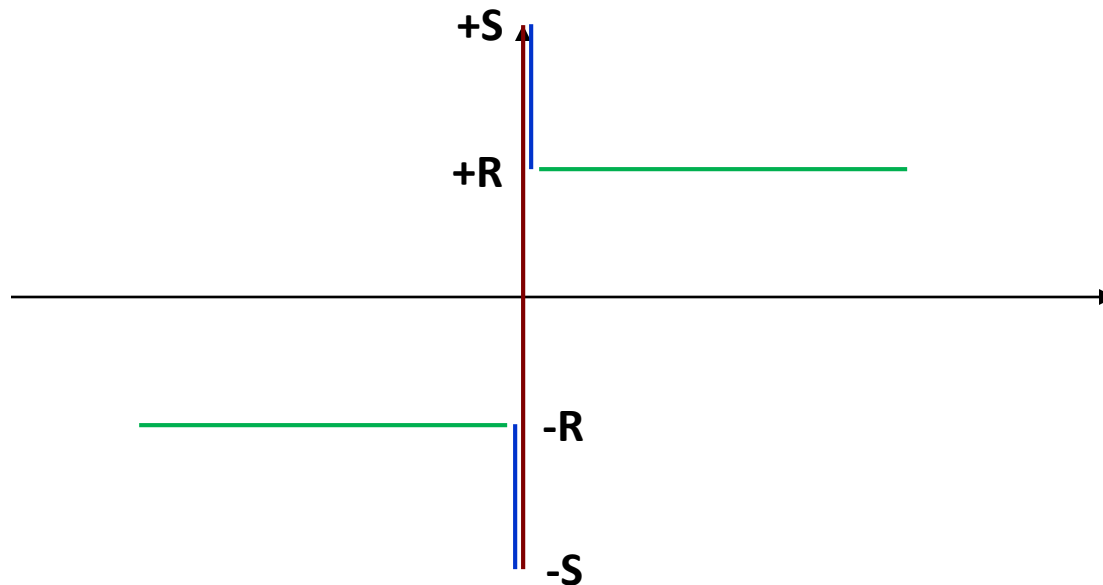

Let us combine what we have learned today by modeling an ideal model for dry-friction.

- In the ideal model, this is a multi-valued function.
- The function contains several modes:

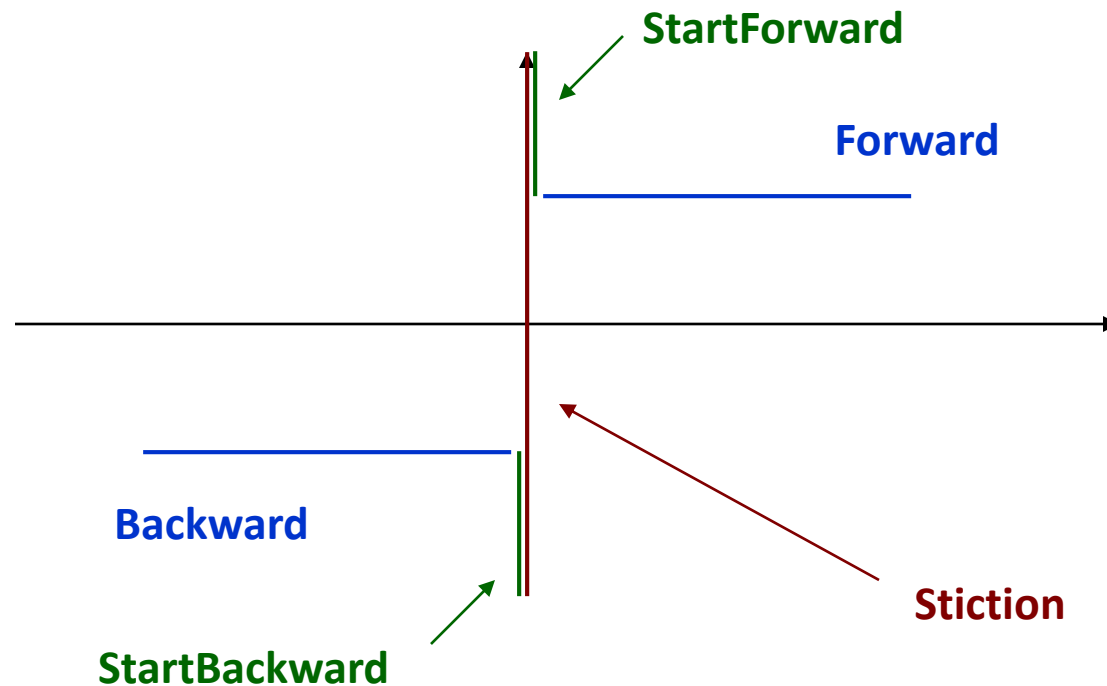

We need to carefully model the transitions between these modes.

- This can be prepared by a mode-transition diagram:

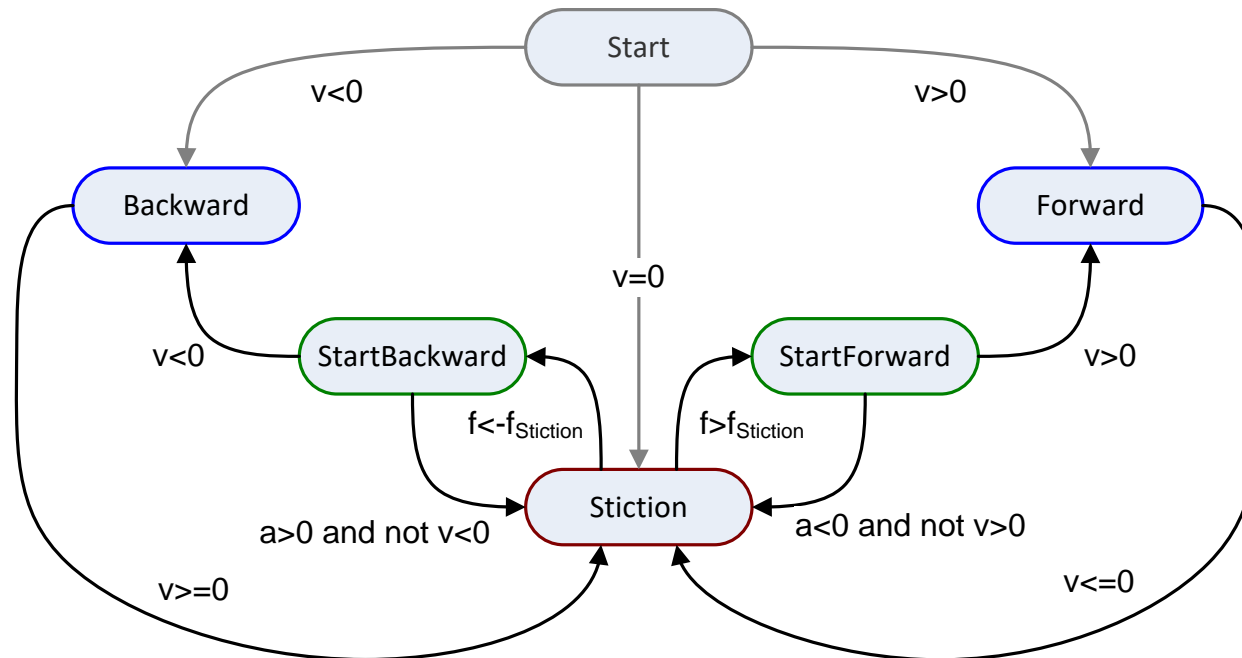

Let us setup the model:

- We use the standard translational interface and derive the velocity and acceleration.
- Two parameters values describe the friction characteristics.
- The modes are represented by a set of Boolean variables.

```
model DryFriction
  parameter SI.Force S = 10;
  parameter SI.Force R = 8;
  Flange_a flange_a;
  SI.Velocity v;
  SI.Acceleration a;
  SI.Force fR;

  Boolean Stiction;
  Boolean StartForw;
  Boolean Forward;
  Boolean StartBack;
  Boolean Backward;

  equation
    v = der(flange_a.s);
    a = der(v);
    [...]

end DryFriction;
```

Let us setup the model:

- The friction force (flange_a.f) is now dependent on the current mode.

```
model DryFriction
  parameter SI.Force S = 10;
  parameter SI.Force R = 8;
  Flange_a flange_a;
  SI.Force fR;
  [...]

equation
  [...]

  flange_a.f =
    if Forward then R
    else if Backward then - R
    else if StartForw then R
    else if StartBack then -R
    else fR;

  0 =
    if Stiction or initial() then a
    else fR;

end DryFriction;
```

Let us setup the model:

- The friction force (`flange_a.f`) is now dependent on the current mode.
- The internal operator `initial()` becomes true just at the moment of initialization. Otherwise, it is false.
- Initially or at Stiction, the acceleration is set to zero and the friction force `fR` is free.
- The conditional constraint `a=0` should actually be `v=0` at least or `s=const`, but this would cause a structural change and cannot be handled by Modelica/Dymola.

```
model DryFriction
  parameter SI.Force S = 10;
  parameter SI.Force R = 8;
  Flange_a flange_a;
  SI.Force fR;
  [...]

  equation
  [...]

  flange_a.f =
    if Forward then R
    else if Backward then - R
    else if StartForw then R
    else if StartBack then -R
    else fR;

  0 =
    if Stiction or initial() then a
    else fR;

end DryFriction;
```

Let us setup the model:

- Now we have to model the mode-transitions according to the diagram.
- We can use the `pre()` operator for this purpose.
- All states must be exclusive.

```
model DryFriction
  parameter SI.Force S = 10;
  parameter SI.Force R = 8;
  Flange_a flange_a;
  SI.Force fR;
  [...]

equation
  [...]
  Forward = initial() and v > 0 or
             pre(StartForw) and v > 0 or
             pre(Forward) and not v <= 0;
  Backward = initial() and v < 0 or
              pre(StartBack) and v < 0 or
              pre(Backward) and not v >= 0;
  StartForw = pre(Stiction) and fR > S or
              pre(StartForw) and not
                (v>0 or a<=0 and not v>0);
  StartBack = pre(Stiction) and fR<- S or
              pre(StartBack) and not
                (v<0 or a>=0 and not v<0);
  Stiction = not (Forward or Backward or
                 StartForw or StartBack);
end DryFriction;
```

Let us setup the model:

- Finally, there is a last issue:
- When the velocity crosses zero and stiction is enforced, we need to set the velocity explicitly to zero.
- To this end, we use the `reinit()`-command. Hence `v` must be a state-variable.

```
model DryFriction
  parameter SI.Force S = 10;
  parameter SI.Force R = 8;
  Flange_a flange_a;

  SI.Velocity v(
    stateSelect=StateSelect.always
  );

  [...]

equation

  [...]

  when Stiction and not initial() then
    reinit(v,0);
  end when;

end DryFriction;
```

- The ideal dry friction model inherits the state machine from the PartialFriction component.
- The key-law is the equation for f .
- f is either determined by the constraint for zero acceleration or determined by the sliding friction coefficient.

```
model IdealDryFriction
  extends ...Translational...PartialCompliant;
  extends ...Translational...PartialFriction;
  parameter Modelica.SIunits.Force S = 10;
  parameter Modelica.SIunits.Force R = 8;

  equation
    free = false;
    f0 = R;
    f0_max = S;
    // velocity and acceleration of flanges
    v_relfric = der(s_rel);
    a_relfric = der(v_relfric);
    // Friction force
    f = if locked then sa*unitForce
    else (if startForward then
          R else
          if startBackward then -
            R else
            if pre(mode) == Forward then
              R else -R);
end IdealDryFriction
```

Let us test our dry-friction model:

- The mass (5kg) has an initial speed of 5m/s
- The (negative) force is ramped up from 0 to 15N

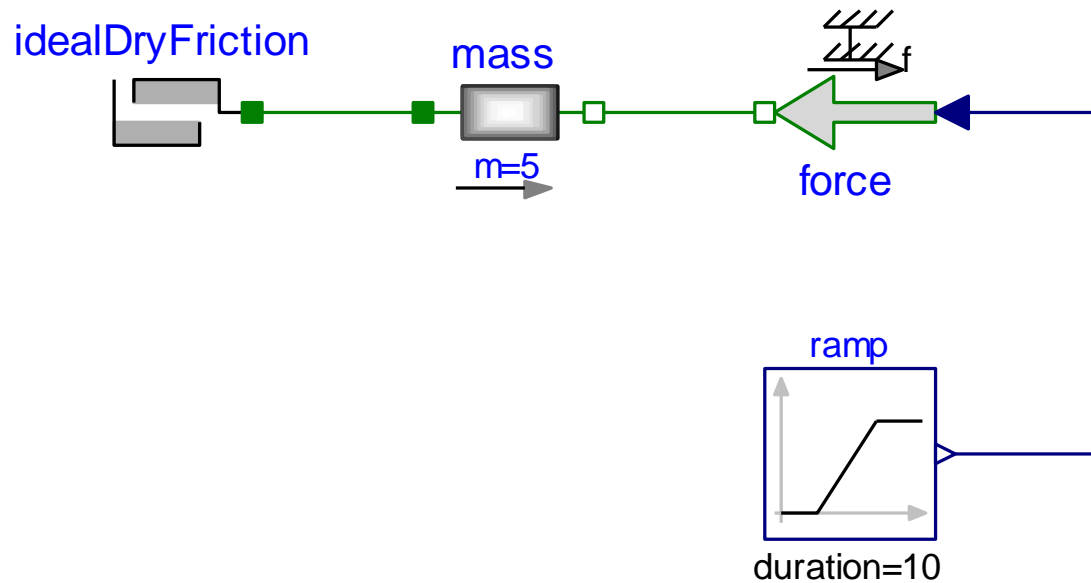

Simulating Dry Friction

Here is the simulation result:

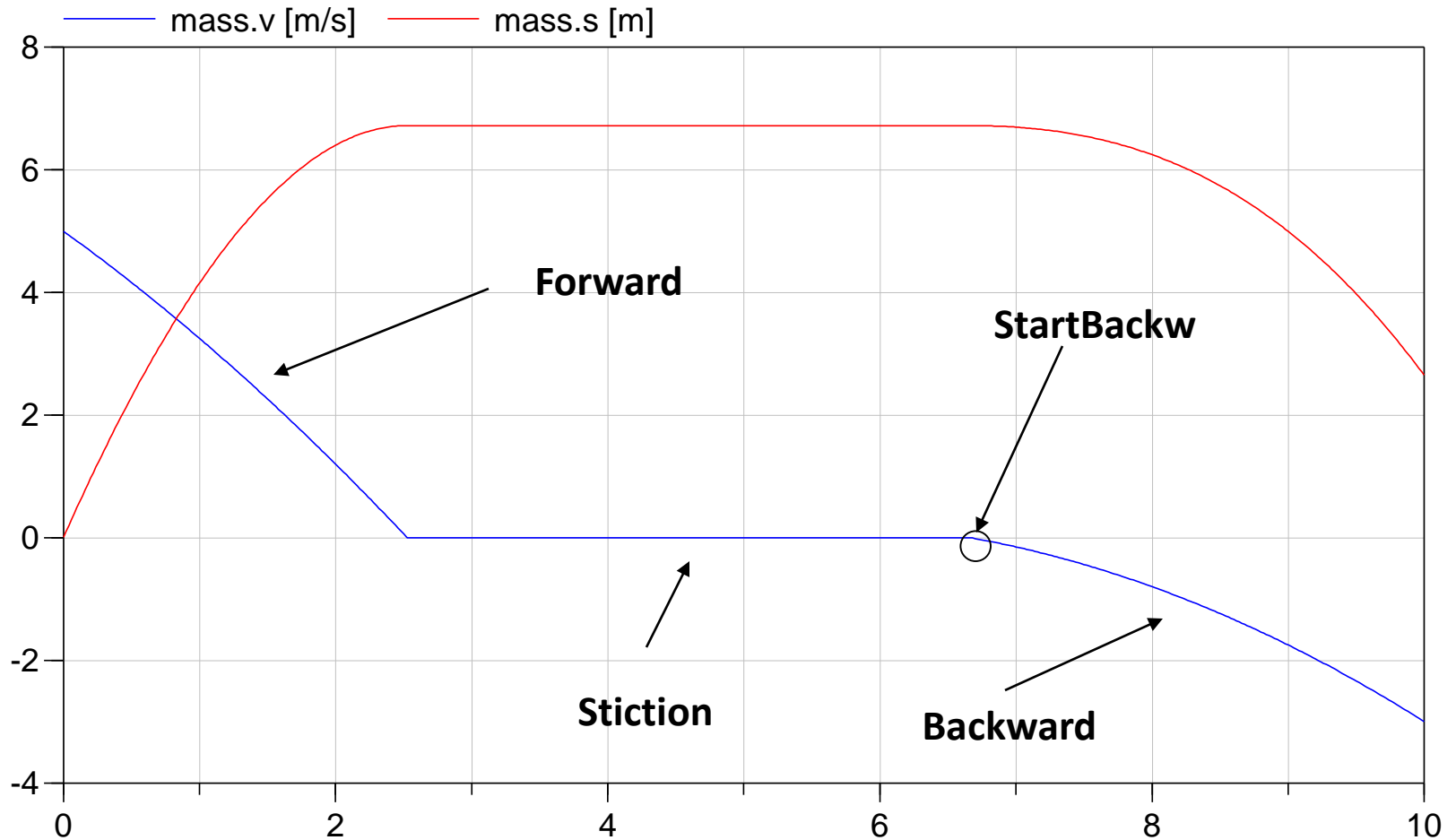

Simulating Dry Friction

This system is more fun.

- Mass1 (5kg) is initially at rest.
- Mass2 (100kg) starts with $v=1\text{m/s}$.

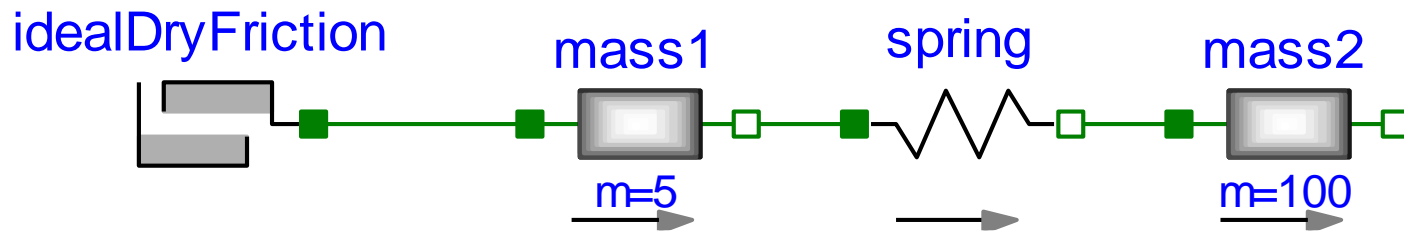

Simulating Dry Friction

Here is the simulation result:

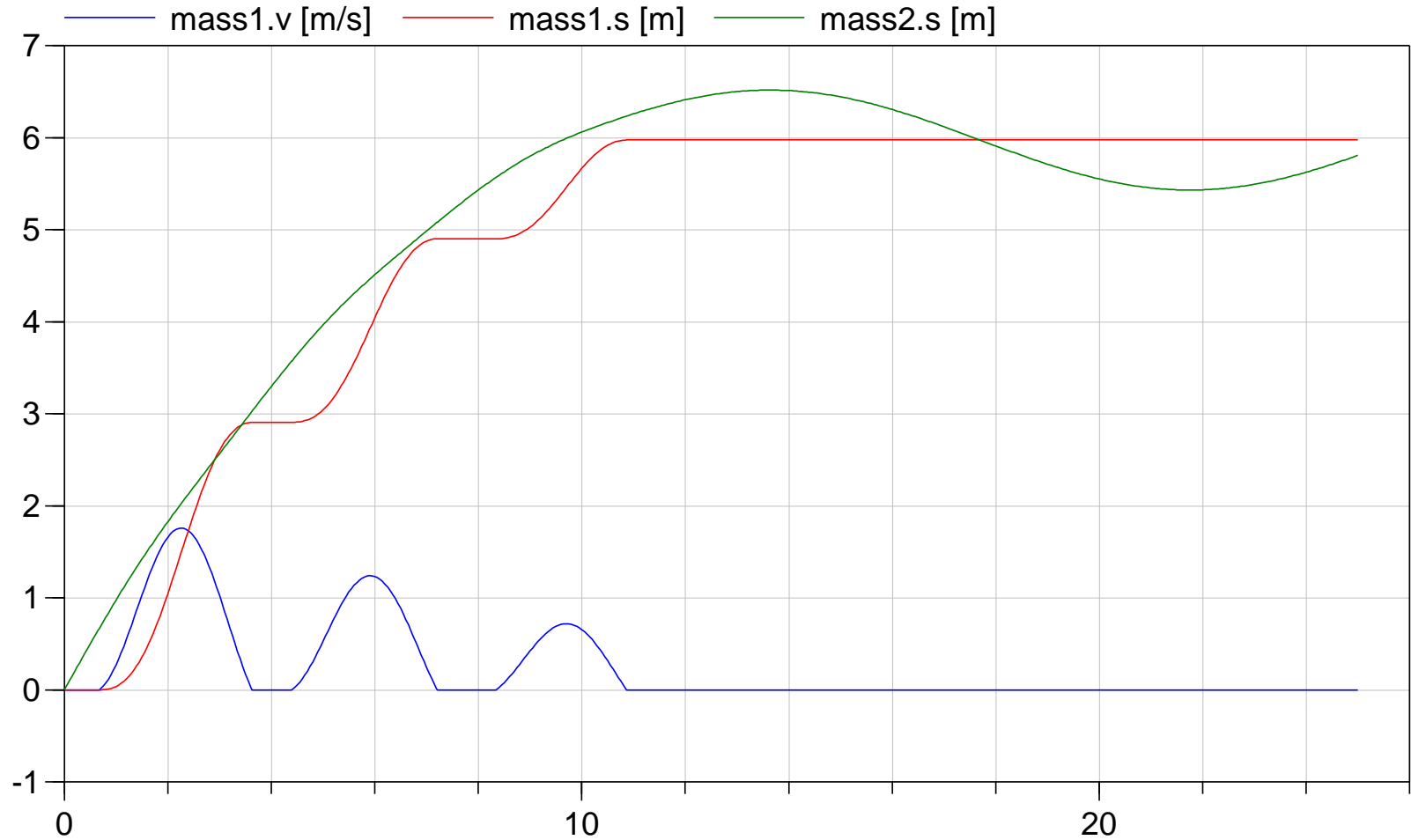

Questions ?

Exercise 12: Light arc

Modelling electric light arc discharges

- No current, if not ignited
- Ignition at $v_{on} = 25\text{kV/cm}$
 - Fixed power regime at low current
 - Resistor regime at high current
 $R \approx v_{off} / i_{min}$
- Extinction at $v_{off} = 5\text{kV/cm}$, $i_{min} = 1\text{ A}$

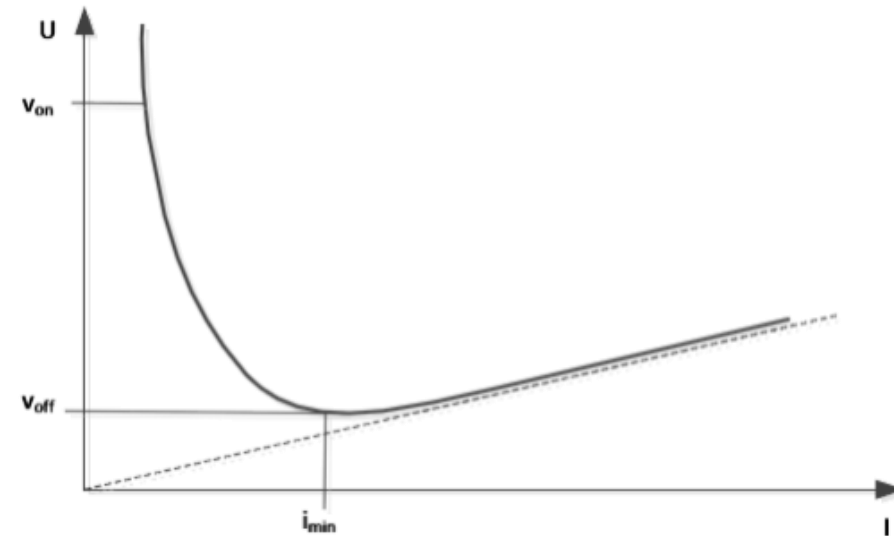

Exercise 12: Light arc

Model a simplified light arc!

- No current, if not ignited
- Ignition at $v_{on} = 25\text{kV/cm}$
 - ~~Fixed power regime at low current~~
 - ~~Resistor regime at high current~~
 $R \approx v_{off} / i_{min}$
- Extinction at $v_{off} = 5\text{kV/cm}$, $i_{min} = 1\text{ A}$

Test your model!

- What happens in the circuit here?
- What happens with an inductance?

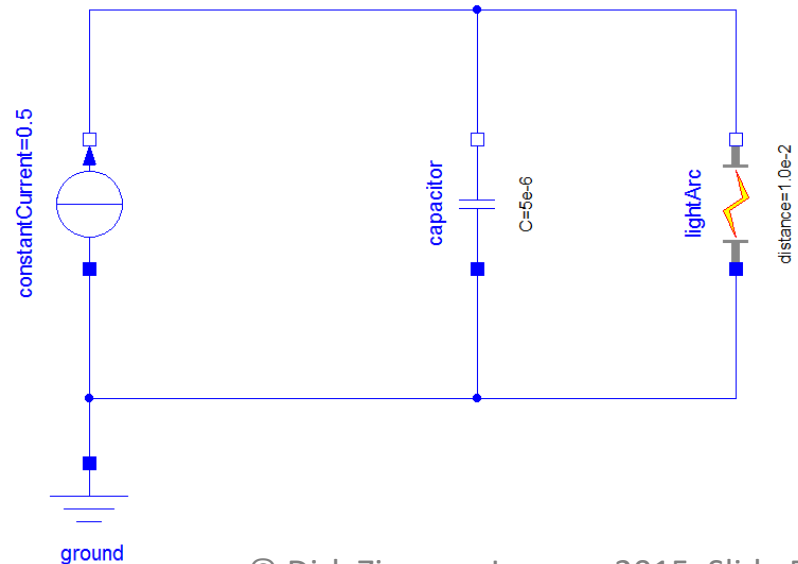
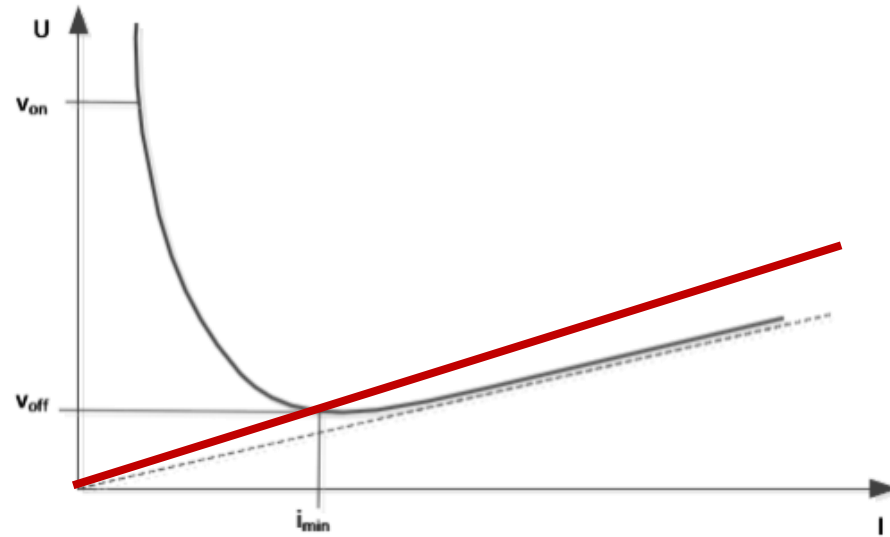

Exercise 12: Light arc

You may use the DryFriction model as a template...

```
model IdealDryFriction_copy

  // Parameters
  parameter Modelica.SIunits.Force S = 10;
  parameter Modelica.SIunits.Force R = 8;

  // Physical variables
  Modelica.SIunits.Velocity v(stateSelect = StateSelect.always);
  Modelica.SIunits.Acceleration a;
public
  Flange_a flange_a;
equation
  v = der(flange_a.s);
  a = der(v);

  // State Machine
public
  Boolean Stiction;
  Boolean StartForw;
  Boolean Forward;
  Boolean StartBack;
  Boolean Backward;
equation
  Forward = initial() and v > 0 or
    pre(StartForw) and v > 0 or
    pre(Forward) and not v <= 0;
  Backward = initial() and v < 0 or
    pre(StartBack) and v < 0 or
    pre(Backward) and not v >= 0;

  //...

  // Equations for different modes
public
  Modelica.SIunits.Force fR;
equation
  flange_a.f = if Forward then R else if Backward then - R else moreStuff;
  0 = if Stiction or initial() then a else fR;

  a
end IdealDryFriction_copy;
```