

Virtual Physics Equation-Based Modeling

TUM, November 22, 2022

2D-Mechanical Systems

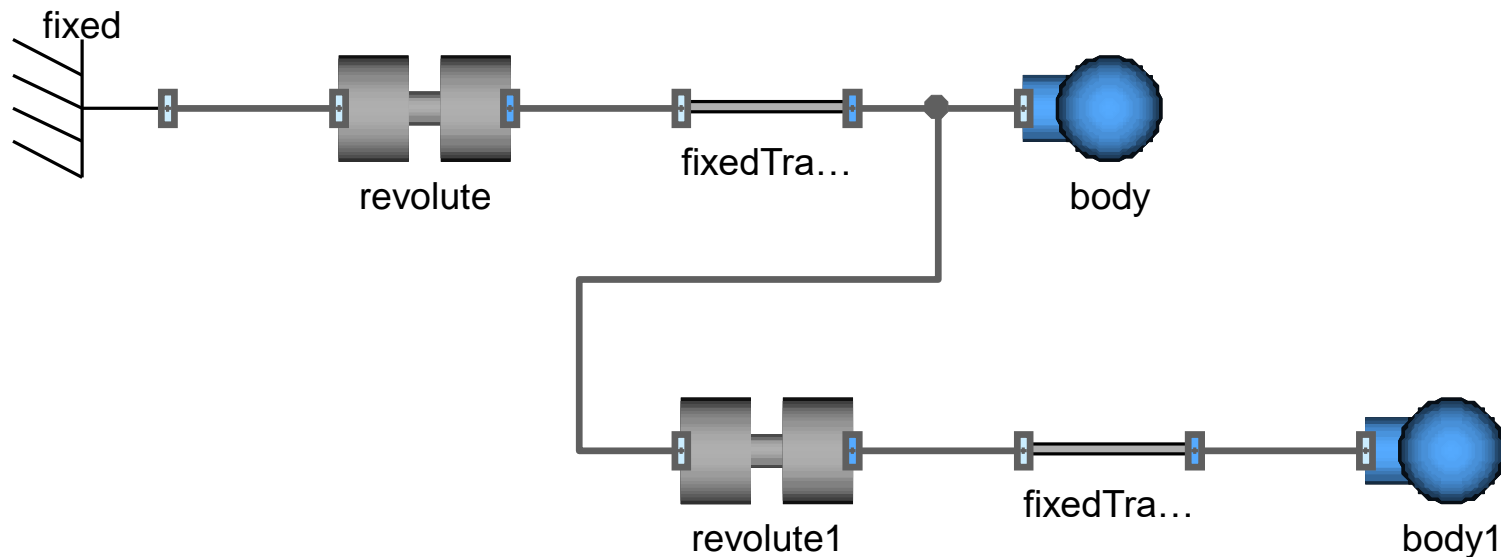

Dr. Dirk Zimmer

German Aerospace Center (DLR), Robotics and Mechatronics Centre

- In planar mechanics, we describe the physics of a multi body system in a two-dimensional plane.

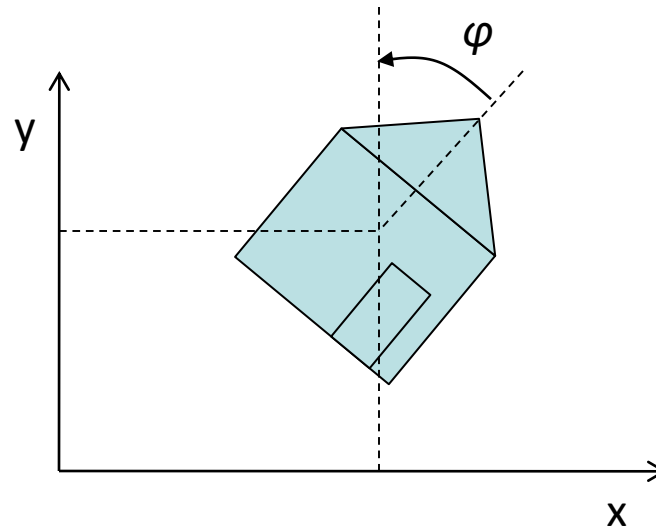

- In the planar world, all motions and positions can be described by two translational positions and an angular orientation
- By convention we denote the horizontal position with x , the vertical position with y and the orientation by the angle φ (phi).

- In this lecture, we want to start modeling our own library for planar mechanics.
- The design of a library is a very multifaceted task. We have to concern:
 - the structure of the library
 - the design of the connector
 - usability of the components
 - effective code reuse
 - solutions for initialization
 - and many things more

- The first question that we have to address concerns how we want to decompose a planar mechanical system into ideal components.
- Let us investigate an example: The crane crab.

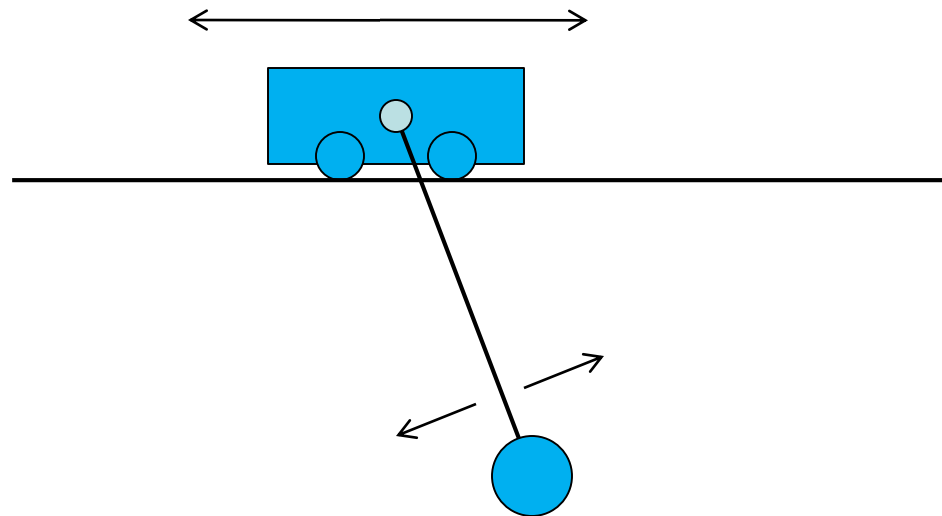

- The crane-crab has two degrees of freedom: The horizontal movement of the carriage wagon and the load revolting like a pendulum.
- The carriage and the load possess mass and an inertia
- The cable has given length.

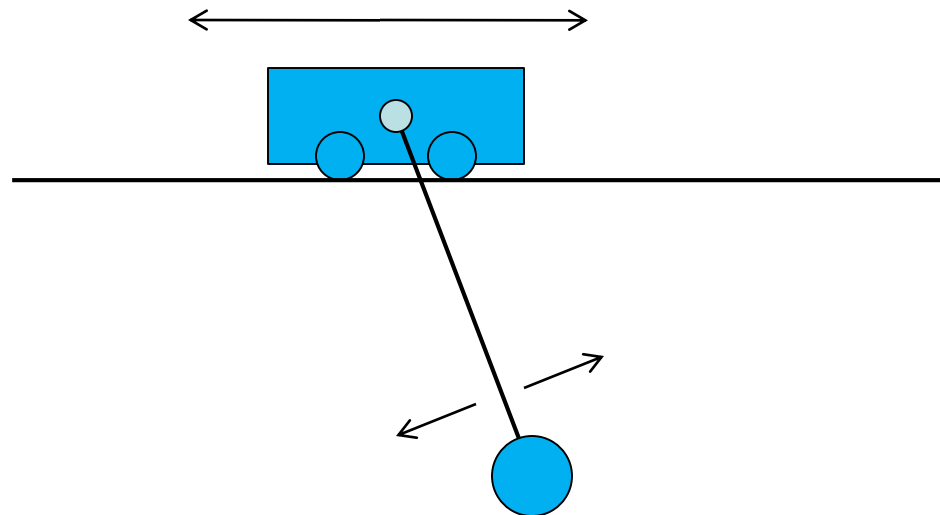

- There shall be one ideal component that represents mass and inertia.
- All other components shall be weightless.
- Some parts represent geometric objects, like a rod of finite length.
- The degrees of freedom in motion can be expressed by special joints.
- Furthermore, there are “force” components like springs and dampers.

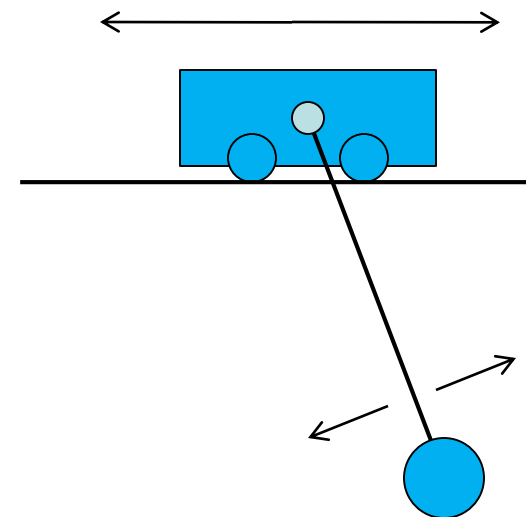

- Here is a quick layout of the library...
- Parts
 - Body (Mass and Inertia)
 - FixedTranslation
 - FixedRotation
- Joints
 - Revolute Joint
 - Prismatic Joint
- Forces
 - Spring
 - Damper

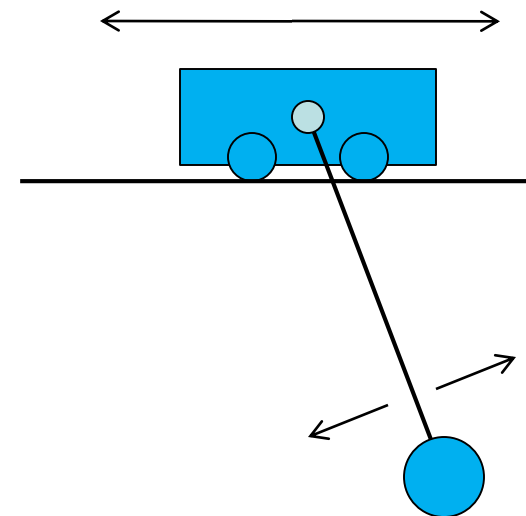

- ...and the corresponding decomposition of the crane crab.

- Parts

- Wall
- Body (Mass and Inertia)
- FixedTranslation

- Joints

- Revolute Joint
- Prismatic Joint

- Forces

- Spring
- Damper

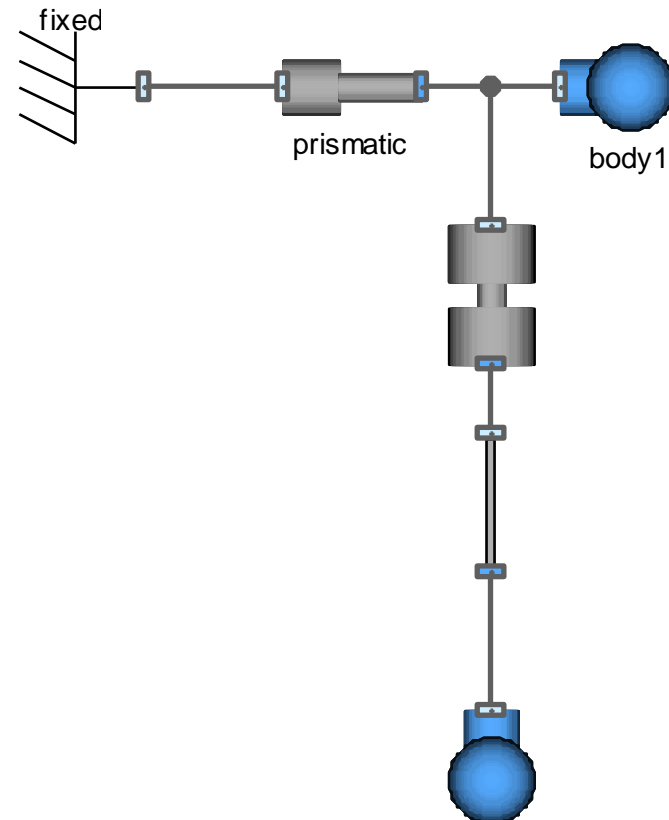

Decomposition into components

- ...and the corresponding decomposition of the crane crab.

- Parts

- Wall
- Body (Mass and Inertia)
- FixedTranslation
- FixedRotation

- Joints

- Revolute Joint
- Prismatic Joint

- Forces

- Spring
- Damper

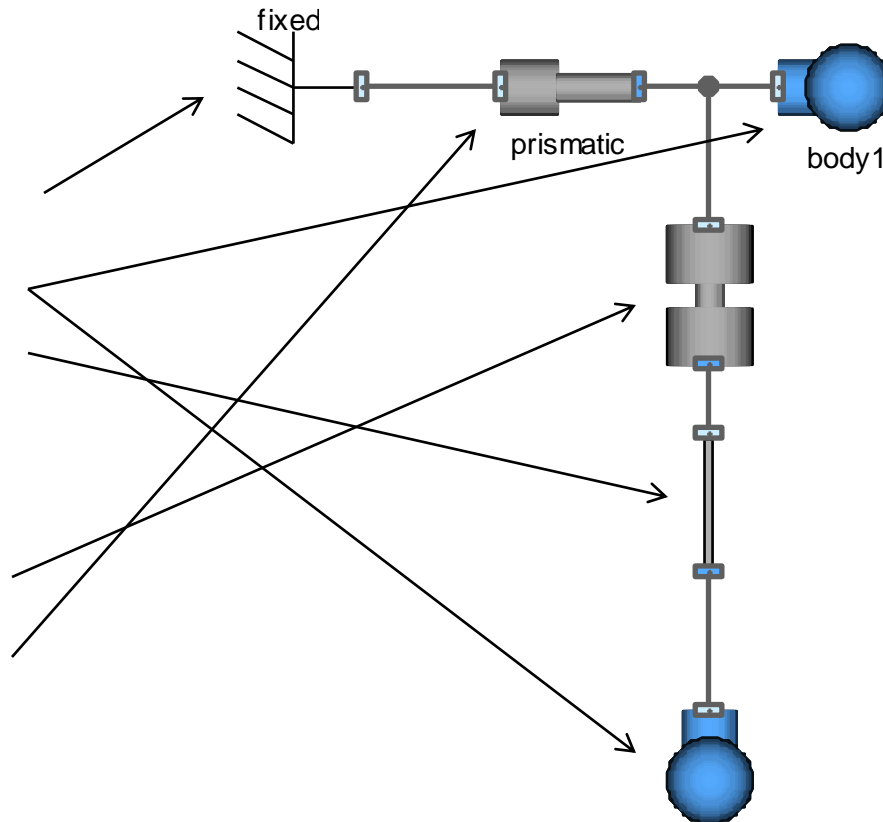

Decomposition into components

- All components of this library shall use one common connector.

- Parts

- Wall
- Body (Mass and Inertia)
- FixedTranslation

- Joints

- Revolute Joint
- Prismatic Joint

- Forces

- Spring
- Damper

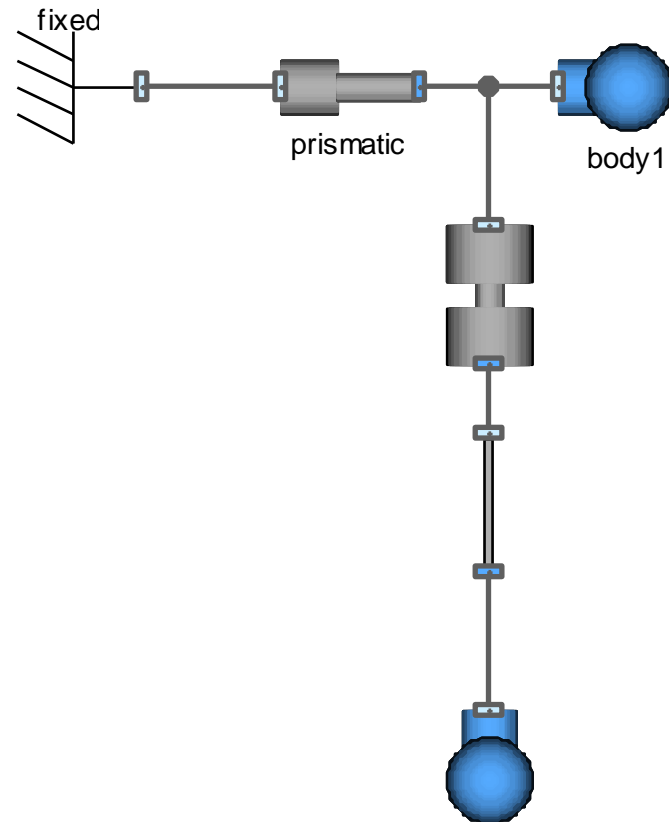

- From 1D-mechanics, we learned that we should choose force and torque as flow-variables and position and angle as potential variables.
- Planar mechanics combine three 1D-subsystems. Hence the following connector design seems natural.

Potential variables

x (horizontal position)

y (vertical position)

φ (orientation angle)

Flow variables

f_x (horizontal force)

f_y (vertical force)

τ (torque)

- Here, the corresponding Modelica-Code:

```
connector Frame "General Connector for planar mechanical components,,  
  
  SI.Position x      "x-position";  
  SI.Position y      "y-position";  
  SI.Angle phi       "angle (counter-clockwise)";  
  flow SI.Force fx   "force in x-direction";  
  flow SI.Force fy   "force in y-direction";  
  flow SI.Torque t   "torque (counter-clockwise)";  
  
end Frame;
```

- It is common style to extend two connectors with different icons from the general connector.
- Some components contain characteristics that are directed. Hence it is helpful to see, if your connecting to side A or side B.

```
connector Frame_a  
  extends Frame;  
end Frame_a;
```



```
connector Frame_b  
  extends Frame;  
end Frame_b;
```



- All of these connectors are collected in an interface package.

We can already model the first basic components. Let us start with the wall component that represents a fixation point.

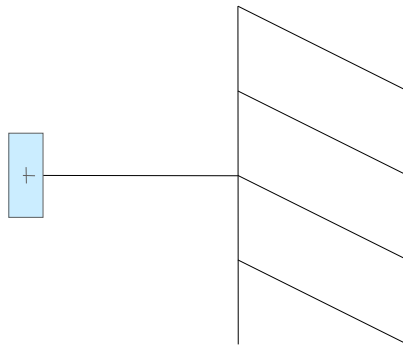

```
model Fixed "FixedPosition"  
  
  Interfaces.Frame_a frame_a;  
parameter SI.Position x = 0  
  "fixed x-position";  
parameter SI.Position y = 0  
  "fixed y-position";  
parameter SI.Angle phi = 0  
  "fixed angle";  
  
equation  
  frame_a.x = x;  
  frame_a.y = y;  
  frame_a.phi = phi;  
  
end Fixed;
```

There is an alternative way to formulate this model. Using the vector notation of Modelica, we can unite the x- and y-positions to a 2-dimensional vector.

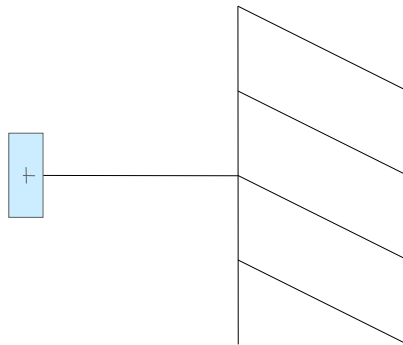

```
model Fixed "FixedPosition"  
  
  Interfaces.Frame_a frame_a;  
  parameter SI.Position r[2] = {0,0};  
    "fixed x-position";  
  parameter SI.Angle phi = 0  
    "fixed angle";  
  
  equation  
    {frame_a.x, frame_a.y} = r;  
    frame_a.phi = phi;  
  
end Fixed;
```

- A little more elaborate is the body-component that represents a mass with inertia.

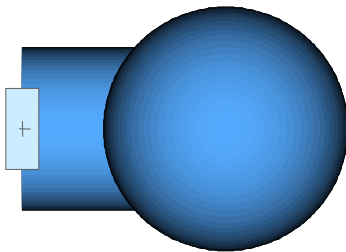

- Essentially, the model formulates Newton's law.

```
model Body
  Interfaces.Frame_a frame_a;

  parameter SI.Mass m;
  parameter SI.Inertia I;

  SI.Force f[2];
  SI.Position r[2];
  SI.Velocity v[2];
  SI.Acceleration a[2];
  SI.AngularVelocity w;
  SI.AngularAcceleration z;

equation
  r = {frame_a.x, frame_a.y}
  v = der(r);
  w = der(frame_a.phi);

  a = der(v);
  z = der(w);

  f = {frame_a.fx, frame_a.fy};
  f = m*a;
  frame_a.t = I*z;
end Body
```

- Since the gravitational force is dependent on the mass ($m \cdot g$), it makes sense to compute right in the body model.

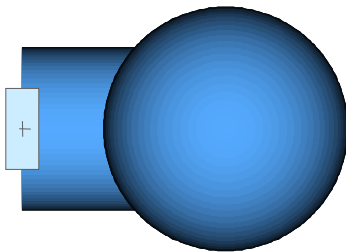

- A parameter for the gravitational acceleration is added and Newton's law is extended.

```
model Body
  Interfaces.Frame_a frame_a;

  parameter SI.Mass m;
  parameter SI.Inertia I;
  parameter SI.Acceleration[2] g={0,-9.81};
  SI.Force f[2];
  SI.Position r[2];
  SI.Velocity v[2];
  SI.Acceleration a[2];
  SI.AngularVelocity w;
  SI.AngularAcceleration z;

equation
  r = {frame_a.x, frame_a.y}
  v = der(r);
  w = der(frame_a.phi);

  a = der(v);
  z = der(w);

  f = {frame_a.fx, frame_a.fy};
  f + m*g = m*a;
  frame_a.t = I*z;
end Body
```

- Vectors of variables, parameters or components can be declared by using rectangular brackets:

```
SI.Position r[2]; or SI.Position[2] r;
```

- A vector can be composed out of scalars by using curly braces:

```
r = {0.2, 13.4}
```

- Vectors can be added and subtracted and be multiplied by scalars:

$$f + m \cdot g = m \cdot a$$

- Vectors can be multiplied with each other. This is the scalar product.

$$v \cdot e$$

- Matrices of variables, parameters or components can be declared by rectangular brackets

`Real R[2,2];` or `Real[2,2] R;`

- A matrix can be expressed row-wise...

`R = {{1,2},{3,4}}` or `R=[1,2;3,4]`

- ...or column-wise

`R = [{1,3},{2,4}]`

1	2
3	4

- Like with vectors, arithmetic operations can be performed on matrices. For instance, the matrix vector multiplication:

`y = R*x;`

- The body model contains 16 scalar variables and 13 scalar equation. There are 3 equation missing from connecting to the interface.
- Nevertheless, we can simulate the body model as a total system.
- This is possible, since for each connector that remains unconnected in the total system, all its flow variables are assumed to be zero.
- This means if we simulate the body model as total system, the following 3 equations are added to the system:

```
frame_a.fx = 0;  
frame_a.fy = 0;  
frame_a.t = 0;
```

- Here is the simulation result:

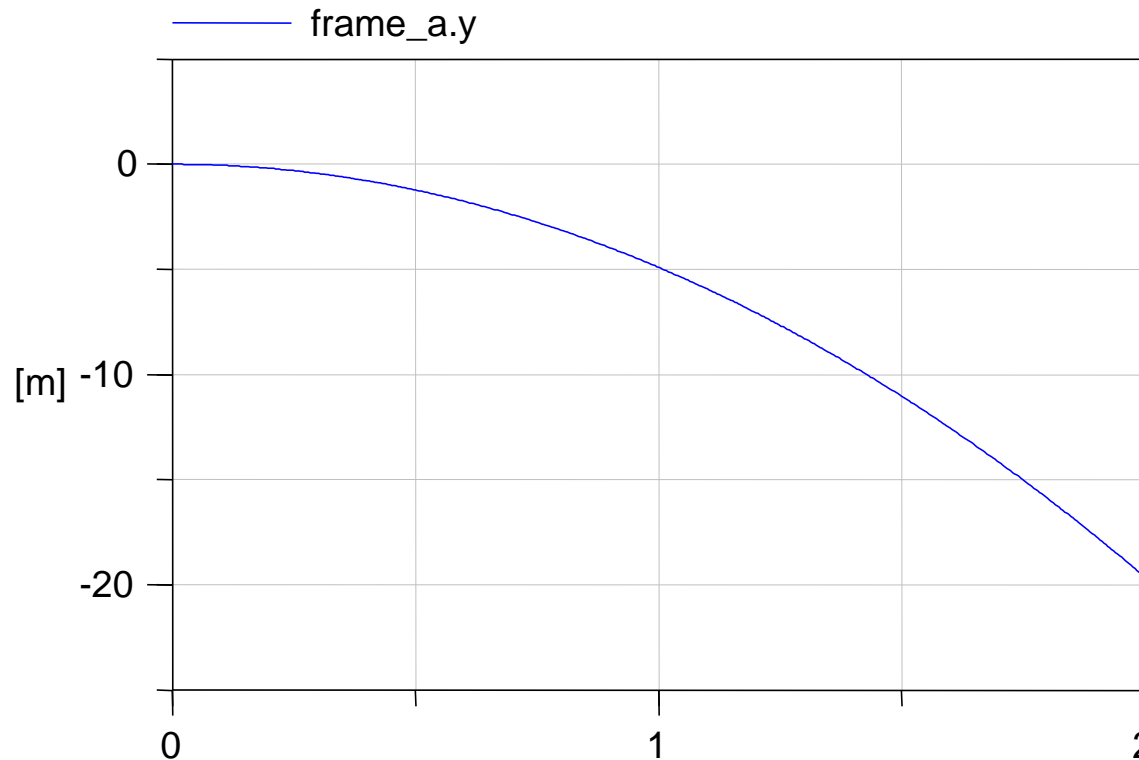

- It shows the parabolic descent of a body due to gravity acceleration.

- Components that have two frames are little more difficult.
- Let us start by modeling a neutral component.
- The model itself is rather meaningless but it represents a good starting point for the design of any new component.

```
model Neutral
  Interfaces.Frame_a frame_a;
  Interfaces.Frame_b frame_b;

equation

  frame_a.fx = 0;
  frame_a.fy = 0;
  frame_a.t = 0;

  frame_a.fx + frame_b.fx = 0;
  frame_a.fy + frame_b.fy = 0;
  frame_a.t
  + frame_b.t
  - (frame_b.x - frame_a.x)*frame_b.fy
  + (frame_b.y - frame_a.y)*frame_b.fx
  = 0;
end Neutral
```

- The model imposes no constraints on the positions.
- This component has two frames, but exhibits no effect.
- The balance equations for the forces contains the lever principle.

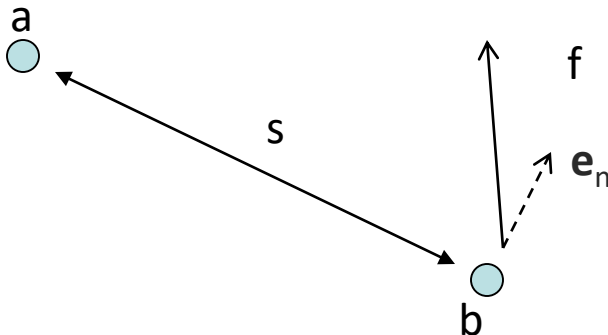

$$\tau = \mathbf{f} \cdot \mathbf{e}_n \cdot s = \mathbf{f} \cdot (\mathbf{e}_n \cdot \mathbf{s})$$
$$\tau = (f_x, f_y) \cdot (-s_y, s_x)$$

```
model Neutral
  Interfaces.Frame_a frame_a;
  Interfaces.Frame_b frame_b;

equation

  frame_a.fx = 0;
  frame_a.fy = 0;
  frame_a.t = 0;

  frame_a.fx + frame_b.fx = 0;
  frame_a.fy + frame_b.fy = 0;
  frame_a.t
  + frame_b.t
  + (frame_b.x - frame_a.x)*frame_b.fy
  - (frame_b.y - frame_a.y)*frame_b.fx
  = 0;
end Neutral
```

Guidelines:

- For each positional constraint we add, we have to remove the corresponding force equation.
- For each variable that we add, we have to add an equation
- Finally, we may be able to simplify the balance equations.

```
model Revolute
  Interfaces.Frame_a frame_a;
  Interfaces.Frame_b frame_b;

equation

  frame_a.fx = 0;
  frame_a.fy = 0;
  frame_a.t = 0;

  frame_a.fx + frame_b.fx = 0;
  frame_a.fy + frame_b.fy = 0;
  frame_a.t
  + frame_b.t
  + (frame_b.x - frame_a.x)*frame_b.fy
  - (frame_b.y - frame_a.y)*frame_b.fx
  = 0;
end Revolute
```

Let us start with the revolute joint:

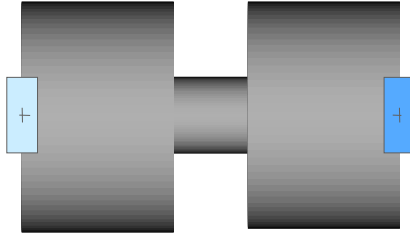

```
model Revolute
```

```
  Interfaces.Frame_a frame_a;
```

```
  Interfaces.Frame_b frame_b;
```

```
equation
```

```
  frame_a.fx = 0;
```

```
  frame_a.fy = 0;
```

```
  frame_a.t = 0;
```

```
  frame_a.fx + frame_b.fx = 0;
```

```
  frame_a.fy + frame_b.fy = 0;
```

```
  frame_a.t
```

```
  + frame_b.t
```

```
  + (frame_b.x - frame_a.x)*frame_b.fy
```

```
  - (frame_b.y - frame_a.y)*frame_b.fx
```

```
  = 0;
```

```
end Revolute
```

Let us start with the revolute joint:

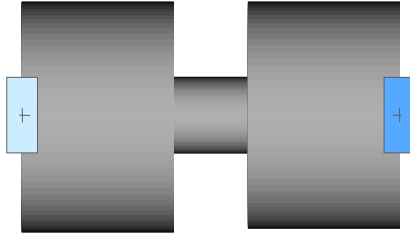

- The translational positions of a and b are equal. (2 constraints)
- No torque can act on the joint.

```
model Revolute
```

```
Interfaces.Frame_a frame_a;
```

```
Interfaces.Frame_b frame_b;
```

```
equation
```

```
frame_a.fx = 0 replaced by
```

```
frame_a.x = frame_b.x;
```

```
frame_a.fy = 0 replaced by
```

```
frame_a.y = frame_b.y;
```

```
frame_a.t = 0;
```

```
frame_a.fx + frame_b.fx = 0;
```

```
frame_a.fy + frame_b.fy = 0;
```

```
frame_a.t
```

```
+ frame_b.t
```

```
+ (frame_b.x - frame_a.x)*frame_b.fy
```

```
- (frame_b.y - frame_a.y)*frame_b.fx
```

```
= 0;
```

```
end Revolute
```

Let us start with the revolute joint:

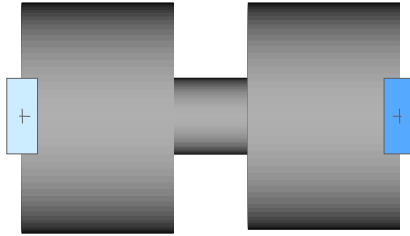

- The translational positions of a and b are equal. (2 constraints)
- No torque can act on the joint.
- The lever principle is redundant here...
- That's it! ...actually

```
model Revolute
  Interfaces.Frame_a frame_a;
  Interfaces.Frame_b frame_b;
```

equation

```
frame_a.fx = 0 replaced by
frame_a.x = frame_b.x;
frame_a.fy = 0 replaced by
frame_a.y = frame_b.y;
frame_a.t = 0;
```

```
frame_a.fx + frame_b.fx = 0;
frame_a.fy + frame_b.fy = 0;
frame_a.t + frame_b.t = 0;
```

```
end Revolute
```

Let us start with the revolute joint:

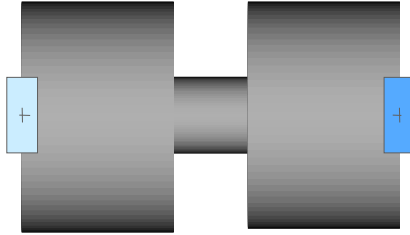

- For completeness, we'd like to add two differential equations for the angle, the angular velocity and its acceleration.
- After all, these variables are of interest.
- We can now use the joint in order to express motion.
- It also helps with initialization.

```
model Revolute
  Interfaces.Frame_a frame_a;
  Interfaces.Frame_b frame_b;

  SI.Angle phi
  SI.AngularVelocity w;
  SI.AngularAcceleration z;

equation
  frame_a.phi + phi = frame_b.phi;
  w = der(phi);
  z = der(w);

  frame_a.x = frame_b.x;
  frame_a.y = frame_b.y;
  frame_a.t = 0;

  frame_a.fx + frame_b.fx = 0;
  frame_a.fy + frame_b.fy = 0;
  frame_a.t + frame_b.t = 0;

end Revolute
```

Let us proceed with a rigid rod:



```
model FixedTranslation
```

```
  Interfaces.Frame_a frame_a;  
  Interfaces.Frame_b frame_b;
```

```
equation
```

```
  frame_a.fx = 0;  
  frame_a.fy = 0;  
  frame_a.t = 0;
```

```
  frame_a.fx + frame_b.fx = 0;  
  frame_a.fy + frame_b.fy = 0;  
  frame_a.t  
  + frame_b.t  
  + (frame_b.x - frame_a.x)*frame_b.fy  
  - (frame_b.y - frame_a.y)*frame_b.fx  
  = 0;
```

```
end FixedTranslation
```

Let us proceed with a rigid rod:



- The length and direction of the rod is determined by the parameter vector r
- This vector is resolved w.r.t the body (coordinate) system.

```
model FixedTranslation
  Interfaces.Frame_a frame_a;
  Interfaces.Frame_b frame_b;

  parameter SI.Length r[2];

equation

  frame_a.fx = 0;
  frame_a.fy = 0;
  frame_a.t = 0;

  frame_a.fx + frame_b.fx = 0;
  frame_a.fy + frame_b.fy = 0;
  frame_a.t
  + frame_b.t
  + (frame_b.x - frame_a.x)*frame_b.fy
  - (frame_b.y - frame_a.y)*frame_b.fx
  = 0;

end FixedTranslation
```

Let us proceed with a rigid rod:



- We need to transform the vector r into the inertial frame r_0 by a 2D rotation:

$$\begin{pmatrix} r_{0x} \\ r_{0y} \end{pmatrix} = \begin{pmatrix} \cos(\varphi) & -\sin(\varphi) \\ \sin(\varphi) & \cos(\varphi) \end{pmatrix} \begin{pmatrix} r_x \\ r_y \end{pmatrix}$$

```
model FixedTranslation
```

```
Interfaces.Frame_a frame_a;
```

```
Interfaces.Frame_b frame_b;
```

```
parameter SI.Length r[2];
```

```
SI.Distance r0[2];
```

```
Real R[2,2];
```

```
equation
```

```
R = {{cos(frame_a.phi), -sin(frame_a.phi)},  
      {sin(frame_a.phi), cos(frame_a.phi)}}
```

```
r0 = R*r;
```

```
frame_a.fx = 0;
```

```
frame_a.fy = 0;
```

```
frame_a.t = 0;
```

```
frame_a.fx + frame_b.fx = 0;
```

```
frame_a.fy + frame_b.fy = 0;
```

```
frame_a.t + frame_b.t
```

```
+ (frame_b.x - frame_a.x)*frame_b.fy
```

```
- (frame_b.y - frame_a.y)*frame_b.fx
```

```
= 0;
```

```
end FixedTranslation
```

Let us proceed with a rigid rod:



- Finally we can use $r0[1]$, $r0[2]$ to formulate the constraint equations and simplify the lever principle.

```
model FixedTranslation
```

```
Interfaces.Frame_a frame_a;
```

```
Interfaces.Frame_b frame_b;
```

```
parameter SI.Length r[2];
```

```
SI.Distance r0[2];
```

```
Real R[2,2];
```

```
equation
```

```
R = {{cos(frame_a.phi), -sin(frame_a.phi)},  
      {sin(frame_a.phi), cos(frame_a.phi)}}
```

```
r0 = R*r;
```

```
frame_a.x + r0[1] = frame_b.x;
```

```
frame_a.y + r0[2] = frame_b.y;
```

```
frame_a.phi = frame_b.phi;
```

```
frame_a.fx + frame_b.fx = 0;
```

```
frame_a.fy + frame_b.fy = 0;
```

```
frame_a.t + frame_b.t
```

```
+ r0*{frame_b.fy, -frame_b.fx} = 0;
```

```
end FixedTranslation
```

Let us proceed with a rigid rod:



- Finally we can use $r0[1]$, $r0[2]$ to formulate the constraint equations and simplify the lever principle.

```
model FixedTranslation
```

```
Interfaces.Frame_a frame_a;
```

```
Interfaces.Frame_b frame_b;
```

```
parameter SI.Length r[2];
```

```
SI.Distance r0[2];
```

```
Real R[2,2];
```

```
equation
```

```
R = {{cos(frame_a.phi), -sin(frame_a.phi)},  
      {sin(frame_a.phi), cos(frame_a.phi)}}
```

```
r0 = R*r;
```

```
frame_a.x + r0[1] = frame_b.x;
```

```
frame_b.y + r0[2] = frame_b.y;
```

```
frame_a.phi = frame_b.phi;
```

```
frame_a.fx + frame_b.fx = 0;
```

```
frame_a.fy + frame_b.fy = 0;
```

```
frame_a.t + frame_b.t
```

```
+ r0*{frame_b.fy, -frame_b.fx} = 0;
```

```
end FixedTranslation
```

The prismatic joint represents a rod with variable length:

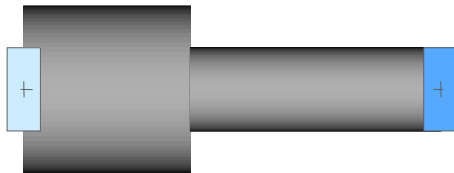

- We can use the FixedTranslation model as a template.
- The final parameter e represents a normalized version of r ;
- The variable s shall represent the length of the rod.
- Hence $r_0 = R * e * s$;

```
model Prismatic
```

```
Interfaces.Frame_a frame_a;  
Interfaces.Frame_b frame_b;  
parameter SI.Distance r[2];  
final parameter Real e[2]  
    = r/sqrt(r*r);  
SI.Distance s;  
SI.Distance r0[2];  
Real R[2,2];
```

```
equation
```

```
R = {{cos(frame_a.phi), -sin(frame_a.phi)},  
      {sin(frame_a.phi), cos(frame_a.phi)}}  
r0 = R*e*s;  
frame_a.x + r0[1] = frame_b.x;  
frame_b.y + r0[2] = frame_b.y;  
frame_a.phi = frame_b.phi;  
  
frame_a.fx + frame_b.fx = 0;  
frame_a.fy + frame_b.fy = 0;  
frame_a.t + frame_b.t  
+ r0*{frame_b.fy, -frame_b.fx} = 0;
```

```
end Prismatic
```

The prismatic joint represents a rod with variable length:

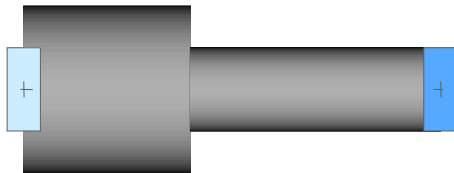

- Since we are relieving one positional constraint by adding the variable s , we have to add one force equation.
- No force can act in direction of the prismatic joint.
- This direction resolved in the inertial system is R^*e ;

```
model Prismatic
```

```
Interfaces.Frame_a frame_a;  
Interfaces.Frame_b frame_b;  
parameter SI.Distance r[2];  
final parameter Real e[2]  
    = r/sqrt(r*r);  
SI.Distance s;  
SI.Distance r0[2];  
Real R[2,2];
```

```
equation
```

```
R = {{cos(frame_a.phi), -sin(frame_a.phi)},  
      {sin(frame_a.phi), cos(frame_a.phi)}}  
r0 = R*e*s;  
frame_a.x + r0[1] = frame_b.x;  
frame_b.y + r0[2] = frame_b.y;  
frame_a.phi = frame_b.phi;
```

```
{frame_a.fx, frame_a.fy}*(R*e) = 0;  
frame_a.fx + frame_b.fx = 0;  
frame_a.fy + frame_b.fy = 0;  
frame_a.t + frame_b.t  
+ r0*{frame_b.fy, -frame_b.fx} = 0;
```

```
end Prismatic
```

The prismatic joint represents a rod with variable length:

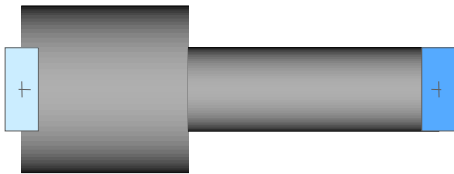

- As for the revolute joint, we would like to add the derivatives v and a .

```
model Prismatic
  Interfaces.Frame_a frame_a;
  Interfaces.Frame_b frame_b;
  parameter SI.Distance r[2];
  final parameter Real e[2]
    = r/sqrt(r*r);
  SI.Distance s;
  SI.Distance r0[2];
  Real R[2,2];
  SI.Velocity v;
  SI.Acceleration a;
equation
  v = der(s);
  a = der(v);
  R = {...};
  r0 = R*e*s;
  frame_a.x + r0[1] = frame_b.x;
  frame_b.y + r0[2] = frame_b.y;
  frame_a.phi = frame_b.phi;
  {frame_a.fx,frame_a.fy}*(R*e) = 0;
  frame_a.fx + frame_b.fx = 0;
  frame_a.fy + frame_b.fy = 0;
  frame_a.t + frame_b.t
  + r0*{frame_b.fy,-frame_b.fx} = 0;
end Prismatic
```

Let us conclude by modeling a damper:



- First of all, the damper does not impose any positional constraints.
- The damping force only acts alongside the damping direction.
- So the lever principle does not apply.

```
model Damper
  Interfaces.Frame_a frame_a;
  Interfaces.Frame_b frame_b;
```

```
equation
```

```
frame_a.fx = 0;
frame_a.fy = 0;
frame_a.t = 0;
```

```
frame_a.fx + frame_b.fx = 0;
frame_a.fy + frame_b.fy = 0;
frame_a.t + frame_b.t = 0;
```

```
end Damper
```

Let us conclude by modeling a damper:



- The direction of the damping force is represented by the variable vector $r0$.

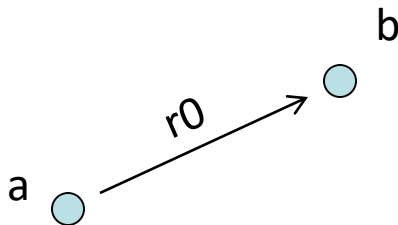

- We see that Modelica supports also vectors (similar to Matlab)

```
model Damper
  Interfaces.Frame_a frame_a;
  Interfaces.Frame_b frame_b;

  SI.Distance[2] r0;

equation

  frame_a.x + r0[1] = frame_b.x;
  frame_a.y + r0[2] = frame_b.y;

  frame_a.fx = 0;
  frame_a.fy = 0;
  frame_a.t = 0;

  frame_a.fx + frame_b.fx = 0;
  frame_a.fy + frame_b.fy = 0;
  frame_a.t + frame_b.t = 0;

end Damper
```

Let us conclude by modeling a damper:



- The direction `e0` is then the normalized version of `r0`.
- The built-in function contains work-around for the case that $r0 = 0$.

```
model Damper
  Interfaces.Frame_a frame_a;
  Interfaces.Frame_b frame_b;

  SI.Length[2] r0;
  Real[2] e0;

equation

  frame_a.x + r0[1] = frame_b.x;
  frame_a.y + r0[2] = frame_b.y;
  e0= Modelica.Math.Vectors.normalize(r0);

  frame_a.fx = 0;
  frame_a.fy = 0;
  frame_a.t = 0;

  frame_a.fx + frame_b.fx = 0;
  frame_a.fy + frame_b.fy = 0;
  frame_a.t + frame_b.t = 0;

end Damper
```

Let us conclude by modeling a damper:



- v_0 represents the relative velocity of the two frames.
- v is then the velocity in direction of the damper e_0 .

$$v = v_d * e_0;$$

```
model Damper
  Interfaces.Frame_a frame_a;
  Interfaces.Frame_b frame_b;
  SI.Length[2] r0;
  Real[2] e0;
  SI.Velocity v0[2];
  SI.Velocity v;

equation
  frame_a.x + r0[1] = frame_b.x;
  frame_a.y + r0[2] = frame_b.y;
  e0 = Modelica.Math.Vectors.normalize(r0);
  v0 = der(r0);
  v = v0*e0;

  frame_a.fx = 0;
  frame_a.fy = 0;
  frame_a.t = 0;

  frame_a.fx + frame_b.fx = 0;
  frame_a.fy + frame_b.fy = 0;
  frame_a.t + frame_b.t = 0;

end Damper
```

Let us conclude by modeling a damper:



- f is the damping force acting in direction $e0$.
- It is proportional to the velocity. This is defined by the damping coefficient d :

$$f = -d*v;$$

```
model Damper
  Interfaces.Frame_a frame_a;
  Interfaces.Frame_b frame_b;
  parameter SI.DampingConstant d;
  SI.Length[2] r0;
  Real[2] e0;
  SI.Velocity v0[2];
  SI.Velocity v;
  SI.Force f;

  equation
    frame_a.x + r0[1] = frame_b.x;
    frame_a.y + r0[2] = frame_b.y;
    e0 = Modelica.Math.Vectors.normalize(r0);
    v0 = der(r0);
    v = v0*e0;
    f = -d*v;
    frame_a.fx = e0[1] * f;
    frame_a.fy = e0[2] * f;
    frame_a.t = 0;
    frame_a.fx + frame_b.fx = 0;
    frame_a.fy + frame_b.fy = 0;
    frame_a.t + frame_b.t = 0;
end Damper;
```

- Finally, we can model the crane crab:

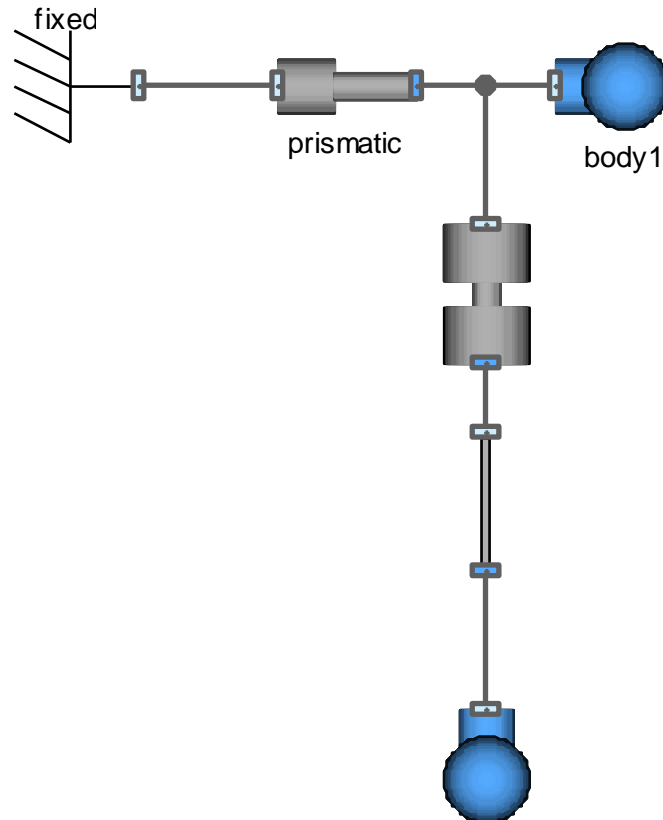

Crane-Crab Results

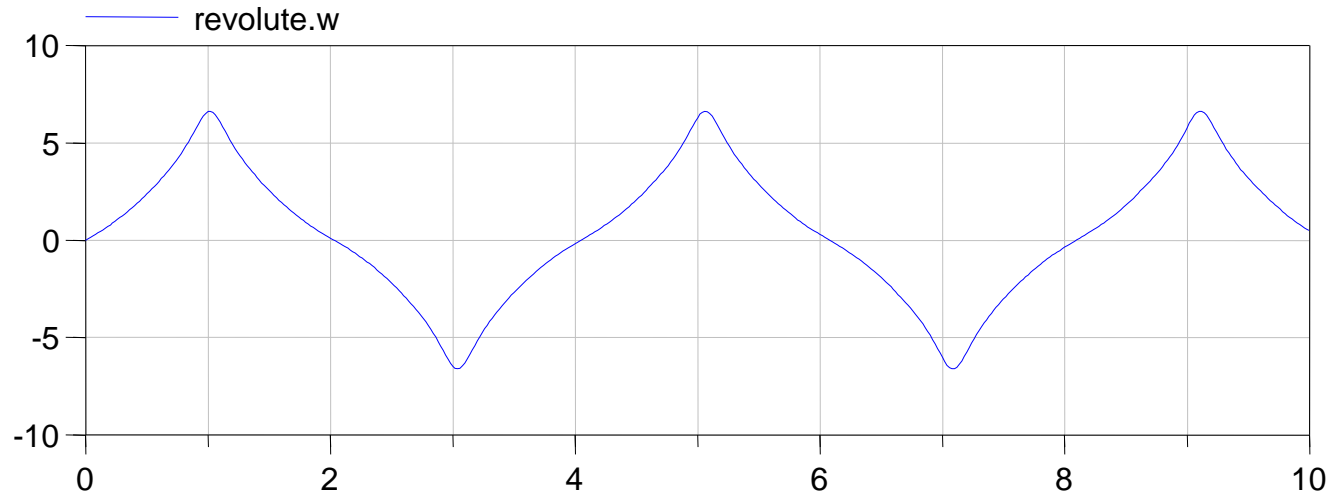
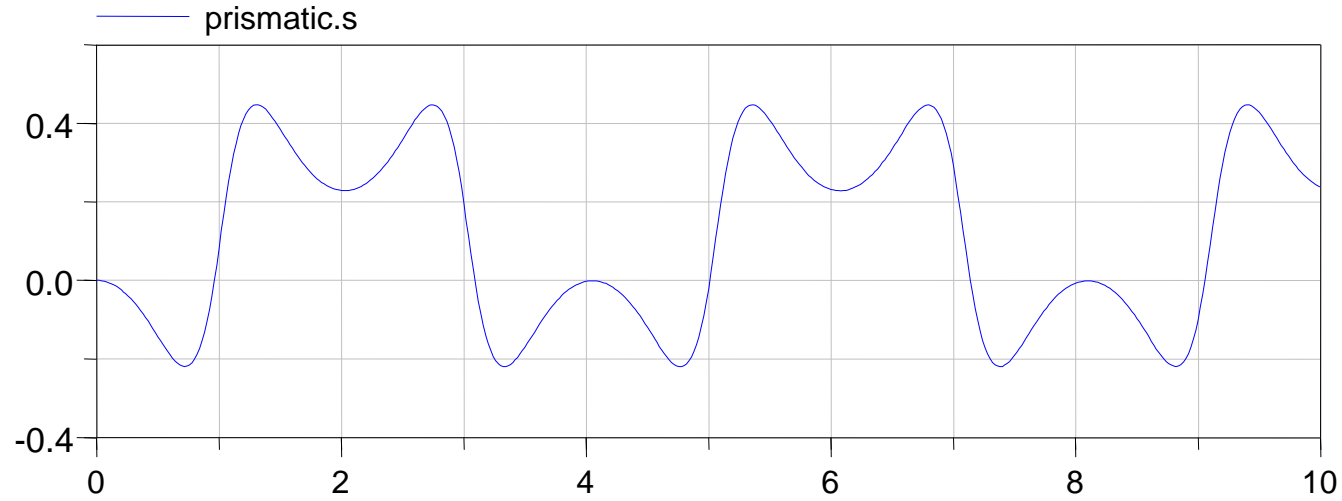

Crane Crab (Damped)

- Here a damped version:

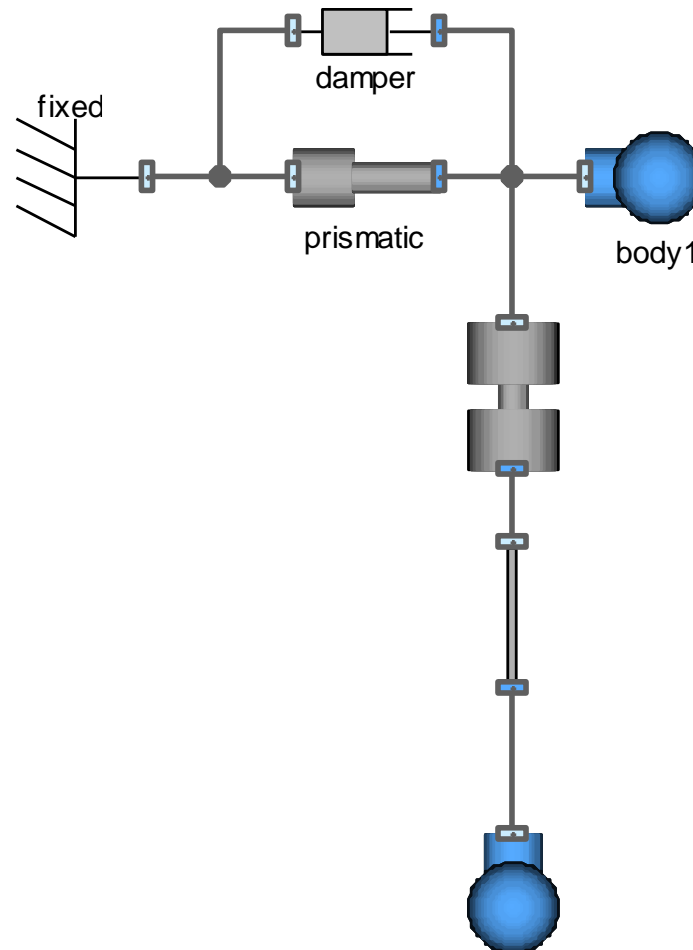

Crane-Crab (Damped) Results

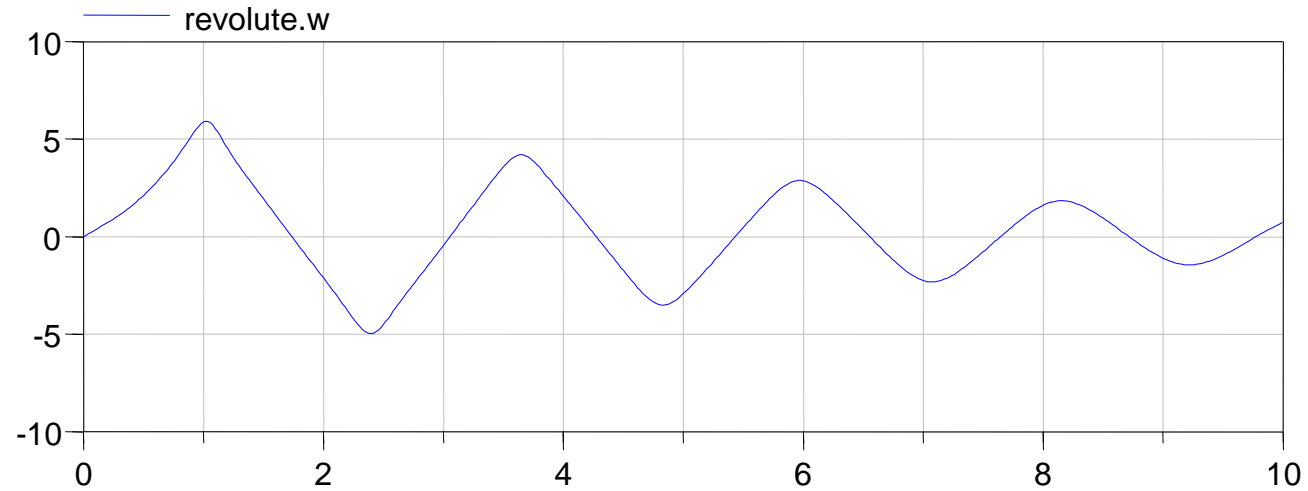
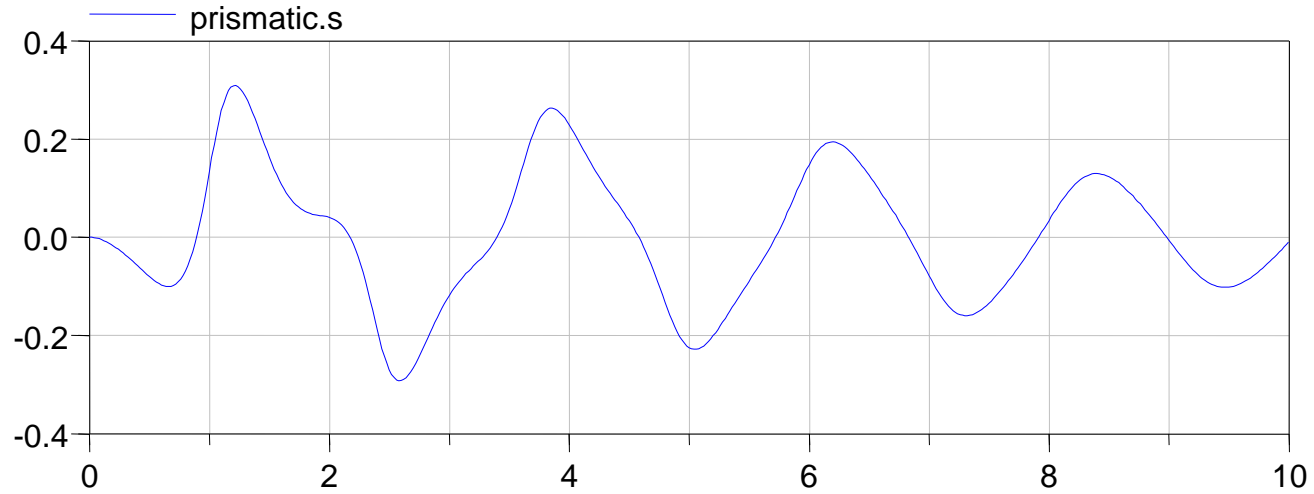

- Looking at plots of mechanical systems isn't that exciting.
- We would like to have a 3D animation of our system.
- Fortunately, Dymola provides an internal support for this.
- We can add elements from the MultiBody library in order to visualize our components.

Let us visualize the fixed translation:



- To this end, we have to add the general visualization component:
MB.Visualizers.Advanced.Shape
- We have to convert our 2D-data into 3D-vectors.

```
model FixedTranslation
```

```
Interfaces.Frame_a frame_a;  
Interfaces.Frame_b frame_b;  
parameter SI.Length r[2];  
SI.Distance r0[2];  
Real R[2,2];  
final parameter SI.Length l = sqrt(r*r);  
  
MB.Visualizers.Advanced.Shape cylinder(  
  shapeType="cylinder",  
  color={128,128,128},  
  specularCoefficient=0.5,  
  length=l, width=0.1, height=0.1,  
  lengthDirection={r0/l,r0/l,0},  
  widthDirection={0,0,1},  
  r_shape={0,0,0},  
  r={frame_a.x,frame_a.y,0},  
  R=MB.Frames.nullRotation());
```

```
equation
```

```
...
```

```
end FixedTranslation
```

Let us visualize the fixed translation:



- Since the animation shall only be optional, we make this component conditional.
- Conditional components can only be accessed in a very limited way. So use this tool moderately.

```
model FixedTranslation
Interfaces.Frame_a frame_a;
Interfaces.Frame_b frame_b;
parameter SI.Length r[2];
SI.Distance r0[2];
Real R[2,2];
final parameter SI.Length l = sqrt(r*r);
parameter Boolean animation = true;

MB.Visualizers.Advanced.Shape cylinder(
  shapeType="cylinder",
  color={128,128,128},
  specularCoefficient=0.5,
  length=l, width=0.1, height=0.1,
  lengthDirection={sx0/l,sy0/l,0},
  widthDirection={0,0,1},
  r_shape={0,0,0},
  r={frame_a.x,frame_a.y,0},
  R=MB.Frames.nullRotation())
  if animation;

equation
...
end FixedTranslation
```

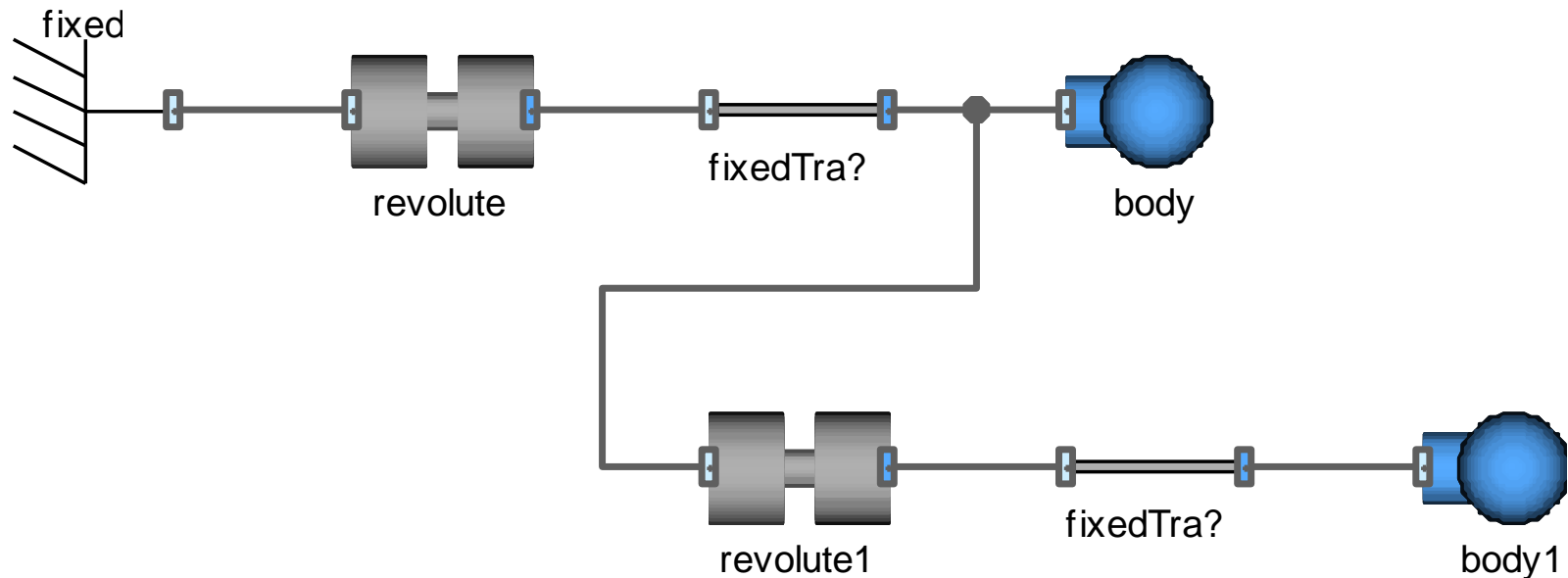

- A seemingly simple system is the double pendulum



- Let us look at the angle of the second revolute joint.

Double Pendulum

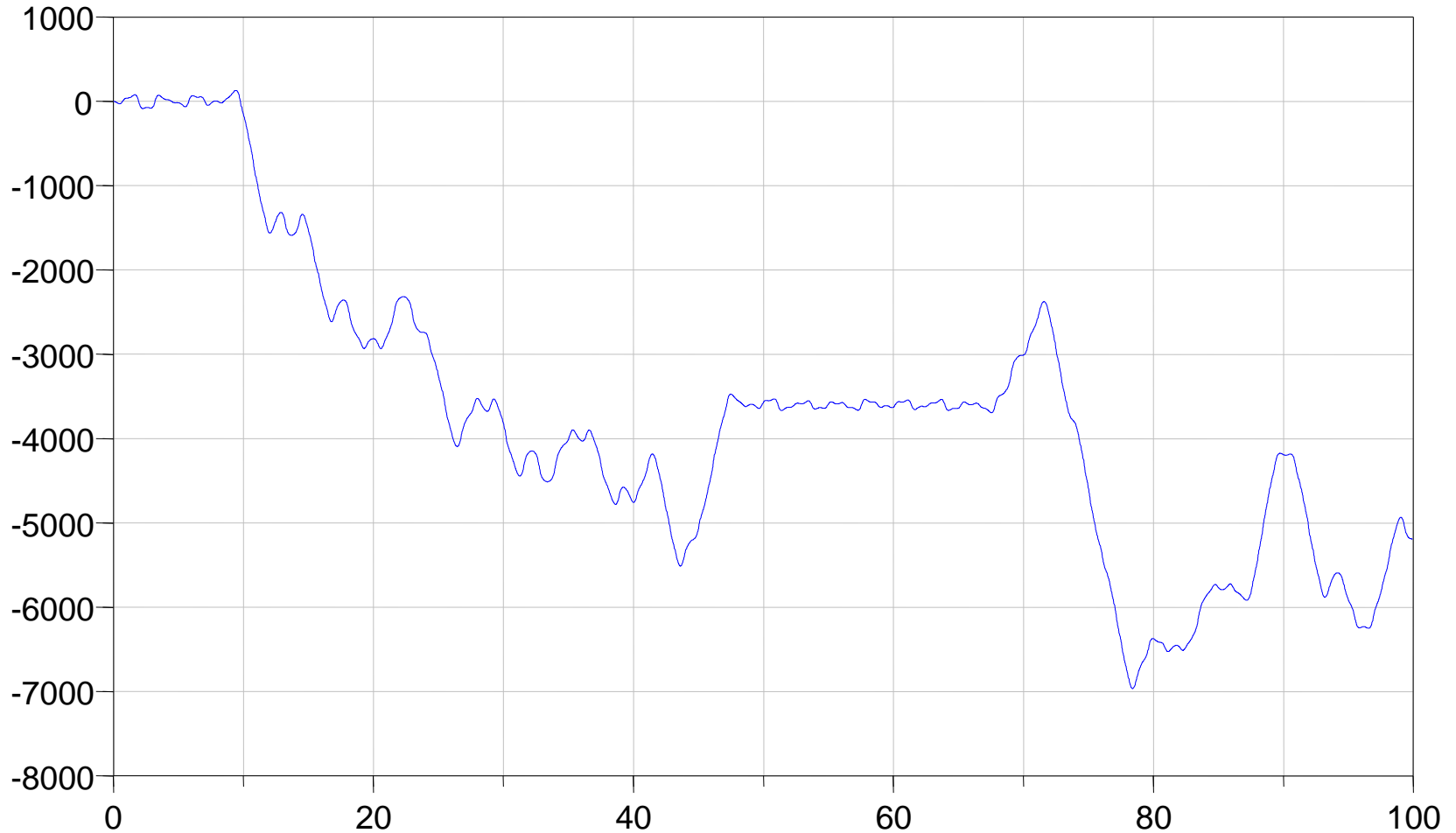
Angle of the small pendulum. Simulated by DASSL with precision 1e-6



Double Pendulum

Angle of the small pendulum. Simulated by DASSL with precision $1e-7$

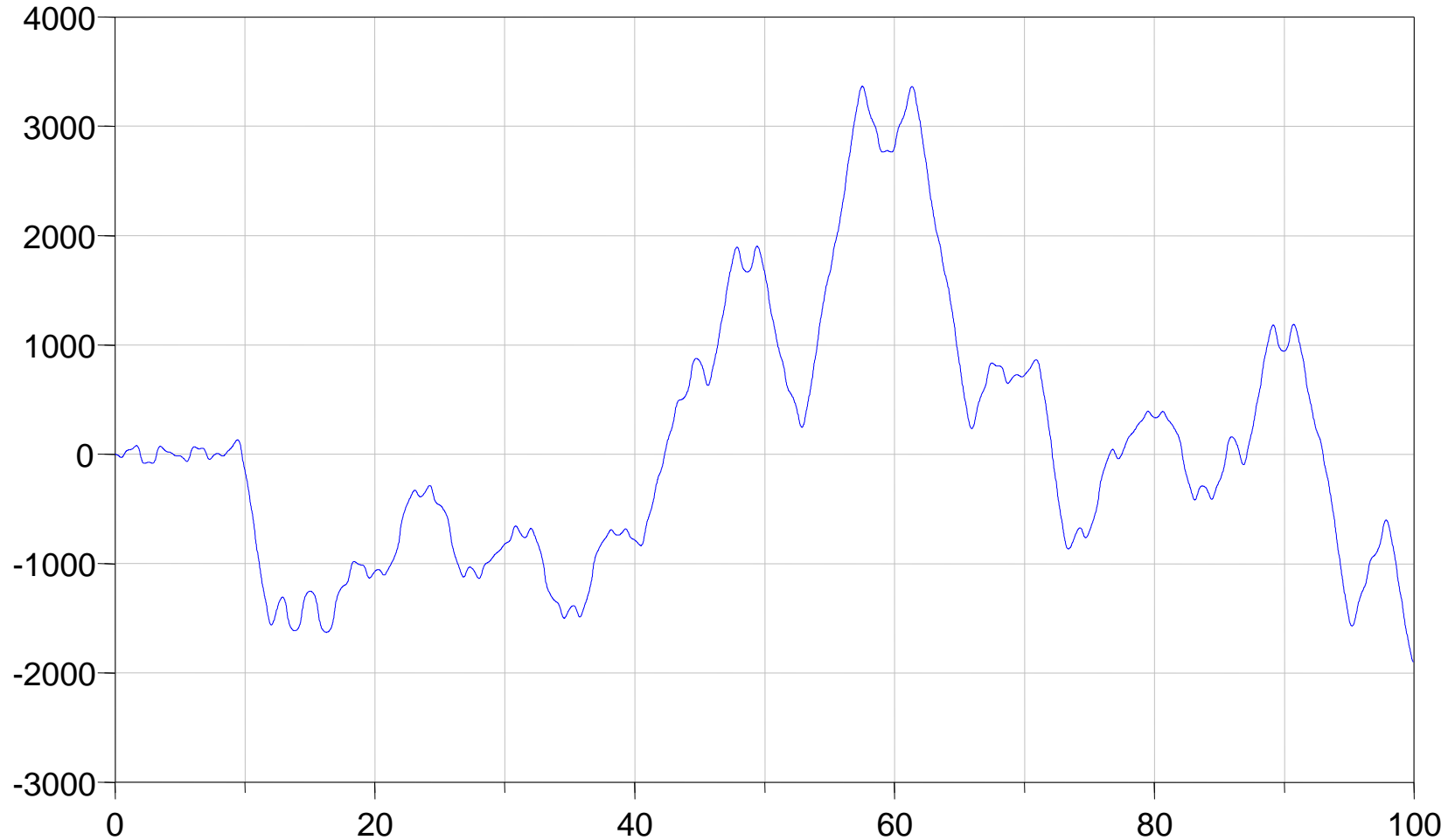

Double Pendulum

Angle of the small pendulum. Simulated by DASSL with precision $1e-8$

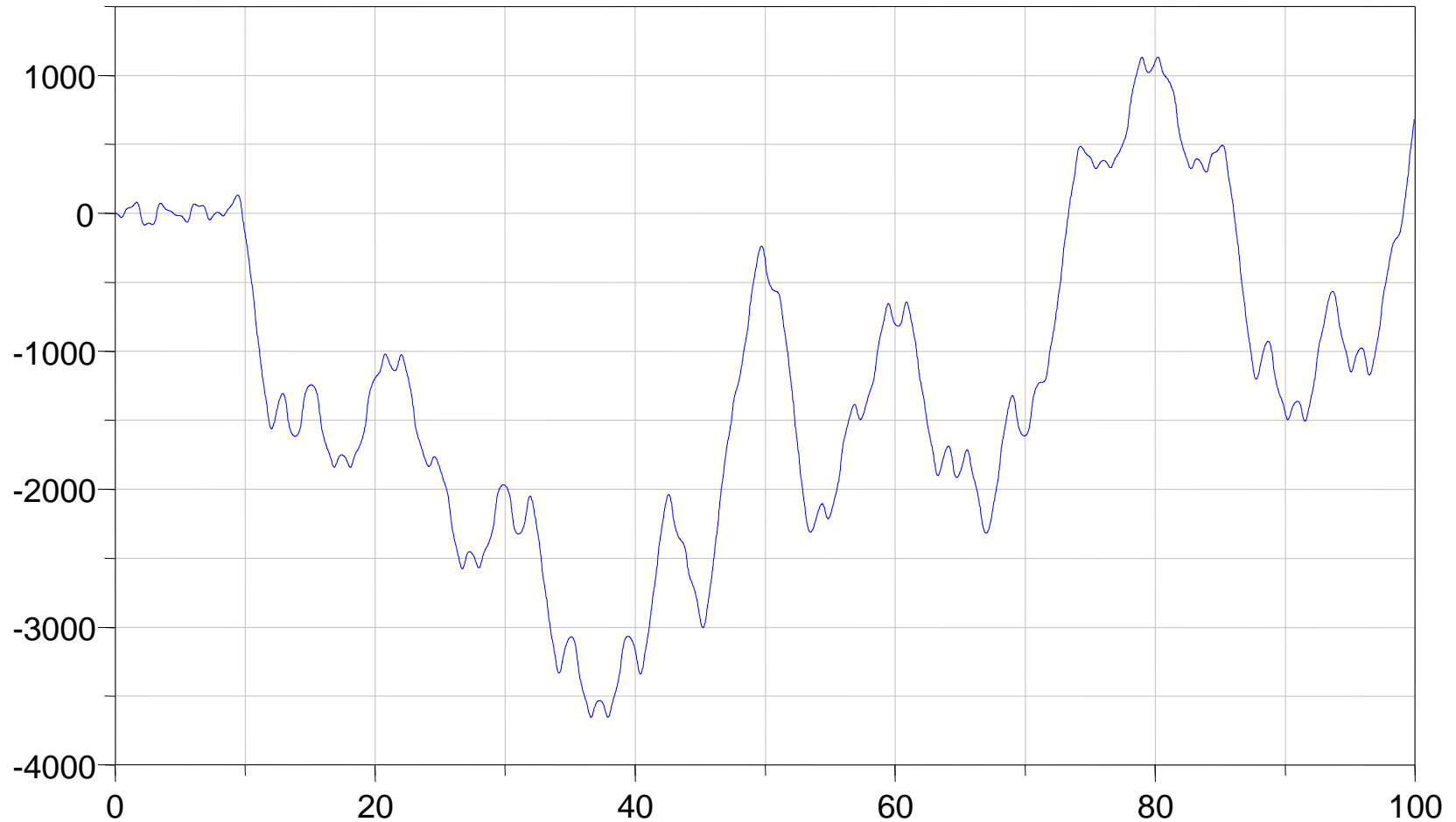

Double Pendulum

Angle of the small pendulum. Simulated by DASSL with precision 1e-9

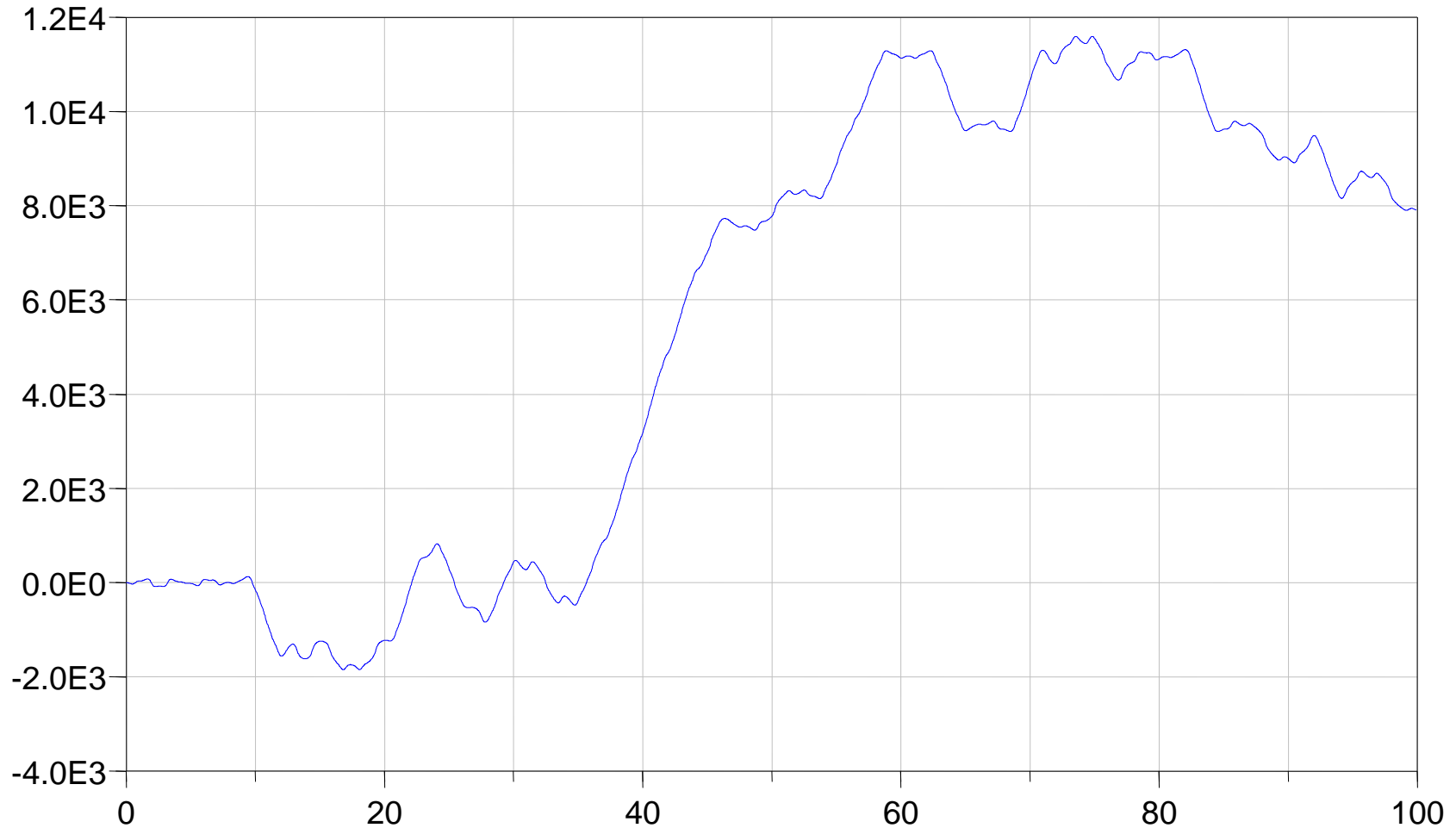

Double Pendulum

Angle of the small pendulum. Simulated by DASSL with precision $1e-10$

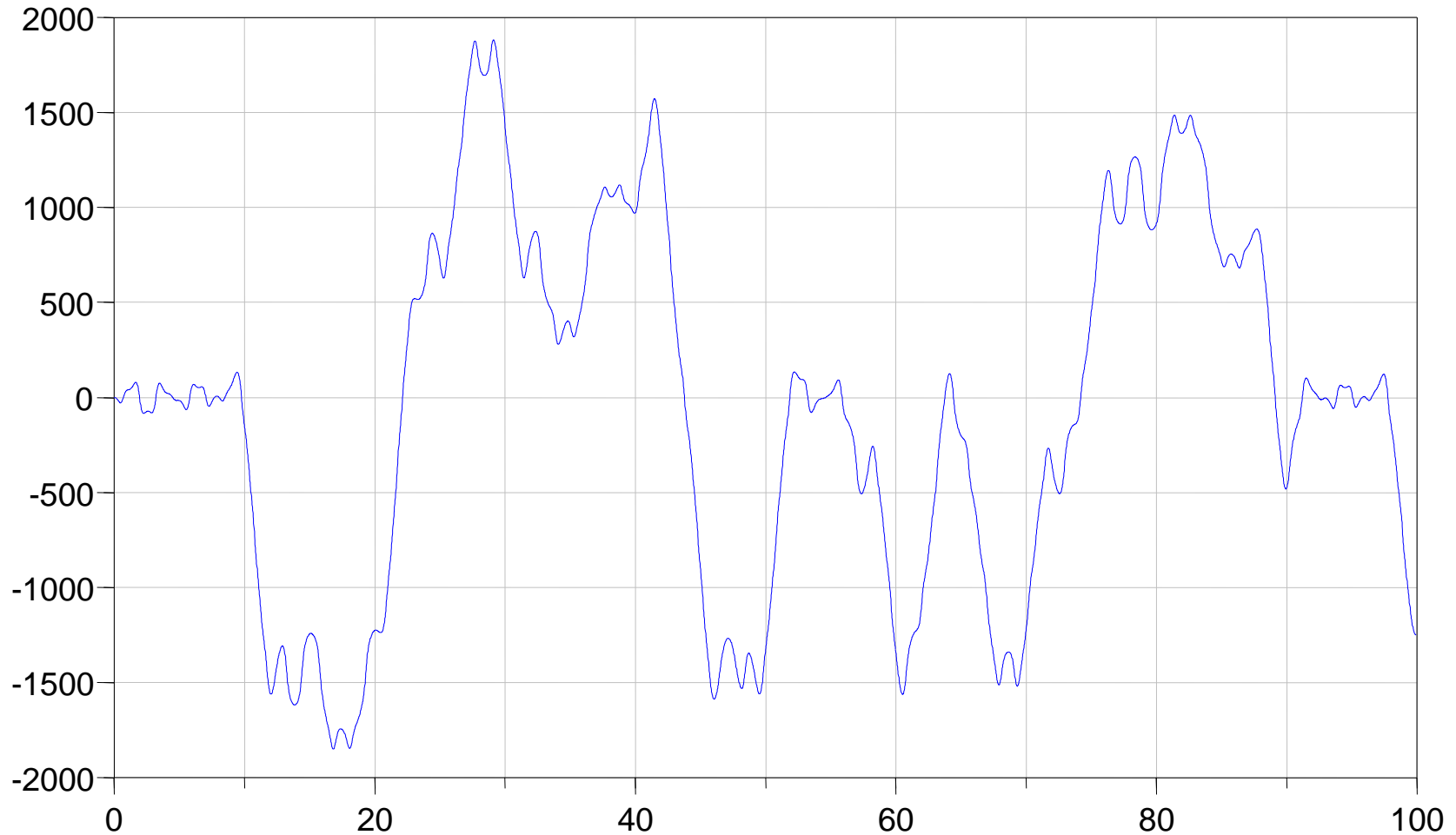

- The simulation does not converge no matter what precision we apply. We have no f*#?ing clue what the state of our system is at $t = 100$.
- The double pendulum is a chaotic system.
- The upright resting position of the second pendulum represents a bifurcation point.
- During simulation, the system will almost inevitable come close to this bifurcation point. Hence the system is extremely sensitive to its initial state.
- Too sensitive to enable any kind of reliable prediction.

- We designed the connector of a planar-mechanical library
- We designed the first component.
- We developed component by starting from a neutral pseudo-component.
- We learned about arrays/vectors in Dymola.
- We assembled the crane crab and a double pendulum.
- We were confronted with a chaotic system.

Questions ?